

Portable Gas Detector XP-3000II Series Instruction Manual

This instruction manual is for the nine models listed below.

- Keep this manual for easy reference.
- Carefully read this manual prior to use.

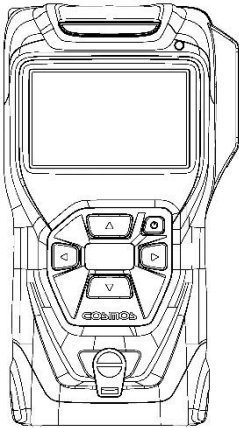

Model Variations		
	Model	Target Gas
1-gas	XP-3310II	Combustible gas (LEL detection)
	XP-3340II	Combustible gas (vol% detection)
	XP-3360II	Combustible gas (ppm detection)
	XP-3360II-W	Combustible gas (LEL & ppm detections)
2-gas	XP-3318II	Combustible gas (LEL detection)+O ₂
	XP-3368II	Combustible gas (ppm detection)+O ₂
	XP-3368II-W	Combustible gas (LEL & ppm detections)+O ₂
O ₂	XP-3380II	Oxygen
	XP-3380II-E	Oxygen in combustion exhaust

NEW COSMOS ELECTRIC CO., LTD.

Table of Contents

	Package Contents	1
	Optional Items (sold separately).....	2
1.	Introduction	3
	Symbols Used in this Manual	3
	Explosion-proof Requirements	4
	Safety Precautions	6
	Precautions for Battery Handling.....	8
	Precautions for Wireless Communication.....	8
2.	Unit and Components	9
	Gas Detector	9
	LCD	10
	1m Gas Sampling Tube (curl cord type).....	11
	Cooling Drain Filter with Cooling Probe Nozzle (only for XP-3380II-E).....	11
	Shoulder Strap	12
3.	Operation	13
	3-1. Preparation	13
	3-1-1. Battery installation.....	13
	3-1-2. 1m gas sampling tube/drain filter/cooling drain filter installation	13
	3-1-3. Shoulder strap installation.....	13
	3-1-4. How to use the stand	13
	3-2. Operating Procedure.....	14
	1. Power on -> Warm-up -> HOME screen	14
	2. Detection.....	16
	3. Power off.....	17
	HOME screen (gas concentrations screen).....	17
	Gas alarm operation.....	18
	3-3. Functions in Normal Operation	19
	3-3-1. Peak hold on/off.....	19
	3-3-2. Trend graph display	20
	3-3-3. Timer.....	20
	3-3-4. Stopwatch	21
	3-3-5. Zero adjustment (zeroing).....	22
	3-3-6. Display device information	22

3-3-7. LCD backlight and flashlight on/off.....	23
3-3-8. Return to HOME screen.....	23
3-3-9. Change unit of measurement (only for XP-3360II-W and XP-3368II-W)...	23
3-3-10. Data logging (for the unit with Bluetooth function installed)	23
3-3-11. Mute audio gas alarm.....	23
3-4. Settings.....	24
3-4-1. Go to setup menu	25
3-4-2. Enter setup mode.....	25
3-4-3. Exit setup mode	25
3-4-4. Operation procedure in each setup mode	25
(A) Change target gas	26
(B) Convert to other gas's concentration (conversion mode)	26
(C) Bluetooth on/off.....	27
(D) Trend graph span setting.....	28
(E) Logging interval rate setting, logging on/off, and log deletion	28
(F) Audio volume control	31
(G) Alarm set value setting and alarm test	32
(H) Clock adjustment.....	33
(I) Language selection.....	33
3-5. Span Adjustment.....	34
3-6. Bump Test.....	35
4. Error Messages.....	36
5. Consumable Replacement.....	38
Battery Replacement.....	38
Charge Batteries	39
Filter Element Replacement.....	40
Sensor Replacement (oxygen sensor)	42
6. Maintenance.....	44
Routine Check.....	44
Annual Inspection.....	45
Cleaning.....	45
Consumable Parts.....	45
7. Troubleshooting.....	46
8. Warranty.....	47
9. Specifications	48
■ Product Specifications.....	48
■ Explosion-proof Specifications	52
■ External Markings for Explosion-proof Models.....	53
10. Disposal	54
11. Detection Principle	55
12. Glossary.....	56

Appendix: Utility for Gas Detector App.....	i
A1. Utility for Gas Detector.....	i
A2. Compatible iOS/Android Devices.....	i
A3. Language Settings.....	i
A4. App Installation and Uninstallation.....	i
A4-1. Installation.....	i
A4-2. Uninstallation.....	ii
A5. Pairing with a Gas Detector.....	iii
A6. Select Device Screen.....	iv
■ Serial Number Entry.....	v
A7. Gas Concentration Screen.....	vi
A8. Temperature and Humidity Screen.....	vii
A9. Display Log Data Screen.....	viii
■ List of Log Data.....	viii
■ Viewing the Contents of the Log Data.....	ix
A10. Settings Screen.....	x
A10-1. Memory Usage & Refresh Screen.....	xi
A10-2. BLE Communication Interval Screen.....	xii
A10-3. BLE Communication Interval Edit Page.....	xiii
A10-4. Turning on the Send Email Function.....	xiv
A10-5. Email Setting Screen.....	xv
A10-6. Account Setting Screen.....	xvi
A10-7. User Setting.....	xvii
A11. Email Notification Sample.....	xviii

Package Contents

A standard package consists of the following items. If any items are missing or damaged, please contact New Cosmos or its authorized representative for replacement.

Item	Quantity
Portable gas detector (with elastomer case)	1
Shoulder strap	1
1m sampling tube (SH-301K-1A) Curl cord type with drain filter and probe nozzle included	1 (Either type)
1m sampling tube for solvent gas detection (SH-401-1A) with drain filter and probe nozzle included	
Cooling drain filter set for XP-3380II-E Cooling drain filter, cooling probe nozzle and case included	
Replacement filter element (FE-2) See "Filter Element Replacement" on page 40	2 (Either type)
Replacement filter element (FE-10) for XP-3380II-E See "Filter Element Replacement" on page 41	
Screen protective film (SPF-1)	3
Toshiba alkaline AA battery (LR6)	4 (Either type)
New Cosmos nickel metal hydride AA battery (HR-3UTG)	
Instruction manual (this document)	1
Inspection certificate	1
Quick start guide	1

Optional Items (sold separately)

Item (model)	Description
Leather case (C-37)	Protects from dirt and scratches
Screen protective film (SPF-1)	Protects the LCD from dirt and scratches (x 3 pcs)
Alligator clip (ST-22)	Use with screws. Use to wear the detector by hanging it on a belt etc.
Drain filter (DF-112)	Metal short probe nozzle to directly be connected to the gas detector's gas inlet
Attachment (AT-2B)	Rubber top for DF-112 drain filter
1m sampling tube (SH-301K-1A)	1m, curl cord type Tube with drain filter and probe nozzle included
Sampling tube (SH-301K-1)	1 m, curl cord type tube
Sampling tube (SH-301-x)	1 m, 2 m, 3 m, 5 m or 10 m selectable (The last digit of the model indicates the tube length)
1m sampling tube for solvent gas detection (SH-401-1A)	Tube with drain filter and probe nozzle included
Sampling tube for solvent gas detection (SH-401-x)	1 m, 2 m, 3 m, 5 m or 10 m selectable (The last digit of the model indicates the tube length)
Cooling drain filter set for XP-3380II-E	Cooling drain filter with cooling probe nozzle (page 11) and case
Cooling probe nozzle (AT-21A-x) for XP-3380II-E	Copper, 200 mm, 500 mm or 1000 mm selectable (The last digit of the model indicates the tube length)
Cooling probe nozzle (AT-21B-x) for XP-3380II-E	SUS, 200 mm, 500 mm or 1000 mm selectable (The last digit of the model indicates the tube length)
Data logger software (XP-3000IIL) *1 and *2	Software to collect and transfer log data to PC (in CD-ROM) and its manual.
Bump tester (EG-129) *3	Checks the indication accuracy with the bump tester mode
Battery charger (BC-10)	Charges batteries installed in the gas detector Serves as an external power supply when the batteries are not installed in the detector
AC adapter	For battery charger/bump tester

*1. Requires a PC that meets the following conditions:

- OS: Microsoft Windows®8.1 or 10 (operation with other OS versions has not been verified)
- Hard disk drive's free space: Approx. 8.0 MB or larger (This is necessary to install the data logger software. Saving log data etc. requires separate space)
- CD-ROM drive for installing the data logger software from CD-ROM
- Built-in Bluetooth module or can connect to a Bluetooth adapter
- Bluetooth 4.0 or higher

Windows®8.1 and 10 are trademarks or registered trademarks of Microsoft Corporation.

Android is a trademark of Google LLC.

iOS is a trademark of Apple Inc. registered in the US and other countries.

Bluetooth® word mark and logos are registered trademarks owned by Bluetooth SIG, Inc.

*2. For use with the unit with Bluetooth function installed when shipped.

*3. Bump tester is intended only for XP-3310II, XP-3318II, XP-3360II-W and XP-3368II-W units in which GAS1 (target gas) is set to methane, isobutane, hydrogen or propane.

See the instruction manual for the bump tester (EG-129, sold separately) for more information.

1. Introduction

Thank you for purchasing the New Cosmos XP-3000II series portable gas detector. Prior to use, please read this instruction manual carefully to ensure safe and reliable operation.

XP-3000II series has single-gas (1-gas) and two-gas (2-gas) models available. 1-gas models measure one combustible gas or oxygen, while 2-gas models simultaneously measure one combustible gas and oxygen. The detector simultaneously displays one or two gas concentrations. When gas concentrations reach a preset level, the detector alerts the user via audible and visual alarms, thus, helping prevent incidents such as low oxygen, gas poisoning and explosion. This detector uses an intrinsically safe structure.

Carefully read this manual, regardless of your experience with gas detectors. Do not use the detector for any purposes other than those intended or described in this manual.



WARNING

Waterproof

Keep the gas detection ports dry.



This detector employs a waterproof structure, which meets the New Cosmos-specified submersion test* compliant with IEC60529 ingress protection code IPX7 in the new condition to prevent malfunctions due to water entry during normal usage. However, if the filter element is wet, proper gas detection is not possible. Gaskets or sealing deteriorated by age, or adhesion of foreign materials will impair the waterproof function; thus, exposure to water should be avoided as much as possible.

*Submersion test procedure:

Submerge a brand new detector into room temperature tap water to a depth of 1 meter for 30 minutes. Verify that water is not present inside the detector.

■ Symbols Used in this Manual

This manual uses Danger, Warning, Caution and Note symbols to draw attention to procedures, materials, methods, and processes, which require particular attention.

 DANGER	Indicates an imminently hazardous situation that can result in death or serious injury.
 WARNING	Indicates a potentially hazardous situation that may result in death or serious injury.
 CAUTION	Indicates a hazardous situation that may result in minor injury or property damage.
NOTE	Provides information on product handling.

Explosion-proof Requirements

Follow the conditions below to comply with the explosion-proof requirements.

Models which use non-rechargeable alkaline AA batteries:

- ATEX: ~~Ex~~II 1G Ex ia da IIC T4 Ga (Other than XP-3380II)
~~Ex~~II 1G Ex ia IIC T4 Ga (XP-3380II)
 IECEX: Ex ia da IIC T4 Ga (Other than XP-3380II)
 Ex ia IIC T4 Ga (XP-3380II)
 UL: Class I, Division 1, Groups A, B, C and D;
 Class I, Zone0 AEx da ia IIC Ga (Other than XP-3380II)
 Class I, Division 1, Groups A, B, C and D;
 Class I, Zone0 AEx ia IIC Ga (XP-3380II)

Models which use rechargeable nickel metal hydride AA batteries:

- ATEX: ~~Ex~~II 1G Ex ia da IIC T3 Ga (Other than XP-3380II)
~~Ex~~II 1G Ex ia IIC T3 Ga (XP-3380II)
 IECEX: Ex ia da IIC T3 Ga (Other than XP-3380II)
 Ex ia IIC T3 Ga (XP-3380II)
 UL: Class I, Division 1, Groups A, B, C and D;
 Class I, Zone0 AEx da ia IIC Ga (Other than XP-3380II)
 Class I, Division 1, Groups A, B, C and D;
 Class I, Zone0 AEx ia IIC Ga (XP-3380II)
 The device has a temperature code of T4 when used with primary cells or
 T3 when used with secondary cells.

- ATEX certificate No.: CML 20ATEX2035X for gas detectors
 IECEX certificate No.: IECEX CML 20.0017X for gas detectors
 UL certificate No.: E108302 for gas detectors
 ATEX certificate No.: CML 19ATEX1374U for combustible gas sensors
 IECEX certificate No.: IECEX CML 19.0118U for combustible gas sensors
 UL certificate No.: E108302 for combustible gas sensors

- Standards: (ATEX) EN60079-0: 2018
 EN60079-1: 2014
 EN60079-11: 2012
 (IECEX) IEC 60079-0: 2017 Edition 7.0
 IEC 60079-1: 2014 Edition 7.0
 IEC 60079-11: 2011 Edition 6.0
 (UL) UL 60079-0 : 7th Edition
 UL 60079-1 : 7th Edition
 UL 60079-11 : 6th Edition
 UL 913 :8th Edition

Electrical data: Four 1.5 V alkaline AA batteries, two in parallel and two in series, or
 Four 1.3 V nickel metal hydride AA batteries, two in parallel and two in
 series.

Batteries to use:

Alkaline batteries: Toshiba alkaline AA battery LR6 x 4pcs,
Panasonic alkaline AA battery LR6X x 4pcs,
Duracell alkaline AA battery MN1500 x 4pcs,
Energizer alkaline AA battery E91 x 4pcs, or
Varta alkaline AA battery 4106 x 4pcs

Rechargeable batteries: New Cosmos nickel metal hydride AA battery HR-3UTG x 4pcs

Silver oxide battery (for the clock):
Sony silver oxide battery SR621W x 1pc, or
Seiko Instruments silver oxide battery SR621SW x pc

Ambient temperature: -20°C to +50°C

Special conditions of use:

- Do not replace batteries when an explosive atmosphere is present.
- Do not charge or carry batteries when an explosive atmosphere is present.
- Only use the detector while installed in its dedicated elastomer case.
- Before opening any parts of the gas detector, ensure that no explosive atmosphere is present.
- The detector must only be charged in a non-hazardous area using the manufacturer's charger type BC-10 (with $U_m = 60\text{ V}$) and in an ambient temperature range of 0 to +40 °C. If the detector is marked for use with T3 only or both T3 and T4, the user shall check the battery type before charging and only attempt to charge the detector if it contains NiMh batteries. Detector marked T4 only, shall not be recharged.
- The batteries shall only be replaced in a non-hazardous area. All four batteries shall be replaced together and shall all be of an identical type.
- If the detector is marked with both temperature classes T3 and T4, before deploying the detector in a hazardous area, the user shall check the battery type via the LCD, and ensure that, if NiMh batteries are fitted, the detector is only used in areas requiring temperature class T3.
- Use of the detector in an atmosphere with greater than 21% of oxygen will compromise the explosion-proof performance of this detector.
- Detector which is marked with temperature class T4 only, shall only fitted with alkaline primary batteries.

Safety Precautions

- To ensure safe operation, follow the precautions below.
- Only use this product in accordance with the applicable laws and regulations.



DANGER

- When a gas alarm is activated, immediately take all the necessary measures to prevent accidents including gas explosion and oxygen deficiency.
- Oxygen-deficient air or toxic gas may be discharged from the gas outlet. Do not inhale.
- High concentration combustible gas may be discharged from the gas outlet. Do not place the gas outlet near an ignition source.



WARNING

- Turn on the gas detector in clean air. Zero adjustment (20.9% adjustment for oxygen) is automatically done during the powering-up. Ensure that the zero adjustment is done in clean air. Inaccurate gas concentrations will be indicated if the zero adjustment is done in a gas atmosphere.
- Do not block any gas inlet and outlet. If blocked, normal detection is not possible.
- Avoid water intake. Water entering the gas sampling tube or gas detector will impair proper gas detection, leading to product failure.
- Do not block the audio opening. If blocked, the audible alarm will be muffled.
- Keep the filter element at the drain filter clean and dry. If the filter element is dirty or wet, proper gas detection is not possible.
- The recommended sensor replacement cycle is three years for combustible gas sensor (two years for oxygen sensor). The sensor may fail to provide accurate detection after three years (two years for oxygen sensor), and should be replaced. See “Annual Inspection” on page 45.
- Only use specified batteries. Using batteries other than those specified may impair the product’s explosion-proof performance.

**CAUTION**

- If this product is to be unused for an extended period of time, remove the batteries from the unit. Failure to do so may cause them to leak or discharge, leading to product failure.
- Even when this product is to be unused for an extended period of time, turn on the product once every 6 months and check that the pump normally works (by running the pump for approx. 3 minutes). If it is unused for an extended period of time, the grease inside the pump motor may become hardened, resulting in a motor malfunction.
- This product is explosion-proof. Do not disassemble, modify, or alter the structure of this unit or its electrical circuits. Doing so may impair the performance of the explosion-proof characteristics.
- Do not modify or use the detector for any purposes other than those intended/described in this manual. Doing so may impair the performance of the product.
- Do not leave the product in high temperature/humidity conditions for a long period of time. Doing so may impair the performance of the product.
- Avoid using the product outside the specified operating temperature/humidity/pressure range. Also, avoid exposing the product to abrupt temperature/humidity/pressure changes. Failure to do so may impair the performance of the product.
- Avoid rapid changes in pressure. Failure to do so may impair the sensor performance or may damage the sensors.
- Avoid strong mechanical shock, impact or vibration to the product by dropping or bumping. Failure to do so may impair the performance of the product.
- If you drop or bump the product by mistake then the reading is fluctuated; allow enough time for the reading to stabilize before use, or perform a zero adjustment/restart the product in clean air.
- If condensation is present on the product, remove it and make sure the unit is completely dried and checked for abnormalities before use.
- This detector may detect gases or solvent gases that are not target gases. Take the usage environment into consideration.
- Do not use the product in a place or near a place where silicone sealant/vapor may be present. Doing so may compromise the performance of the product.
- Detecting high concentration of sulfur dioxide or chlorine may shorten the sensor life or increase errors.
- As the oxygen sensor has pressure dependence, make necessary pressure adjustments when using the detector at a place other than sea-level, such as at high altitude.
See "Detection Principle" on page 55.
- The gas sensors may contain harmful substances. For disposal, return them to New Cosmos or treat them as industrial waste.
- When used at low temperature, the battery life will be shorter than when used at room temperature due to the battery's characteristics.
- Keep the detector away from wireless devices, while in use. Failure to do so may cause a fault alarm or fluctuations in the reading due to radio wave interference.

Precautions for Battery Handling

This product uses four batteries. Follow the precautions below for safe use of batteries.



WARNING

- Dispose of used batteries in accordance with the applicable laws and regulations.
- Improper use of batteries may lead to battery leakage, excessive heat, ignition or explosion.
 - Do not short-circuit.
 - Do not disassemble, deform or modify.
 - Do not heat or throw batteries into a fire.
 - Do not expose/immerse to/in freshwater or seawater.
 - Avoid thermal, electrical and mechanical impact.
- Avoid using the batteries outside the specified operating temperature/humidity/atmospheric pressure range (see 9. "Specifications" on pages 48 to 51 for the range). Misuse of the batteries may compromise the performance of the product, which may then result in a gas leak or explosion.



CAUTION

- Remove the batteries from the device if it is unused or stored for an extended period of time. Store batteries in a clean and dry place at a temperature of 30°C or lower to prevent degradation.
- Avoid rough handling of battery cartons. Rough handling of battery cartons may lead to battery damage and impaired electrical performance and may result in leakage, explosion or heat generation.

Precautions for Wireless Communication

Follow the precautions below to comply with the applicable Radio Laws.



WARNING

- This product complies with the following radio laws.
 - EU: RE directives
 - Japan:  [R] 001-A10746
- Using the product's Bluetooth outside the EU and Japan is prohibited. Do not bring it to outside the EU and Japan.
- Do not modify the product. Use of the modified product is a violation of the Radio Laws.

2. Unit and Components

Gas Detector

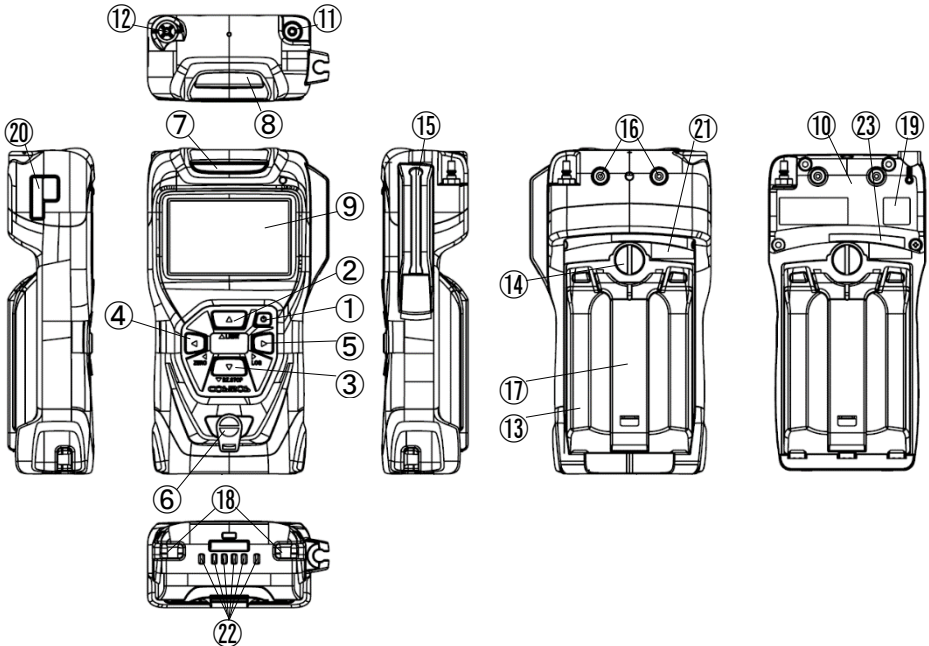

Item	Component	Function
①	Power button	Used to turn the detector on/off or move to the gas concentrations screen (HOME) The unit of measurement is switchable (%LEL<->ppm) for only XP-3360II-W and XP-3368II-W models
②	▲ button	Used to turn the LCD backlight and flashlight on/off, and make selection during setting
③	▼ button	Used to mute audio gas alarm, and make selection during setting
④	◀ button	Used to start zero adjustment, display device information, and return to the previous step during setting
⑤	▶ button	Used to go to the menu for make settings, restore the pump operation when a pump error occurs, and confirm selection/setting
⑥	Audio opening	Opening for audio
⑦	Alarm light	Blinks red when a gas alarm is detected; Blinks yellow when a device error (e.g., pump error, sensor failure) is detected
⑧	Flashlight	Lights up the area
⑨	LCD	Displays gas concentrations, error message and guidance See the next page for more information
⑩	Back cover	Secures the sensors to the unit
⑪	Gas inlet	Connects a gas sampling tube or optional DF-112 drain filter (or cooling drain filter for EP-3380II-E)
⑫	Gas outlet	Discharges sampled gas

Unit and Components

Item	Component	Function
⑬	Battery cover	Cover for battery compartment
⑭	Battery cover lock	Unlock/lock the battery cover
⑮	Sampling tube holder	Holds a gas sampling tube
⑯	Screw hole (2 places)	Used to attach an alligator clip (sold separately) with two screws
⑰	Stand	The detector can operate while standing on a desk
⑱	Strap hole (2 places)	Thread a shoulder strap's end through the hole to attach the strap to the detector
⑲	CE marking label / UL marking label	See page 53
⑳	Manufacturing label	Indicates model, serial number and manufacturing year and month. See page 53
㉑	Warning/Caution label	Indicates warning/caution for use in a hazardous area. See page 53
㉒	Charging terminal	Connects a battery charger (sold separately)
㉓	Gas name label	Indicates model and target gas(es)

LCD

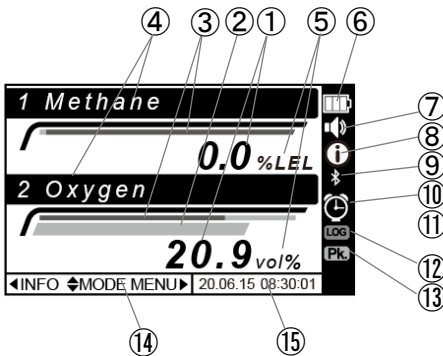

2-gas model

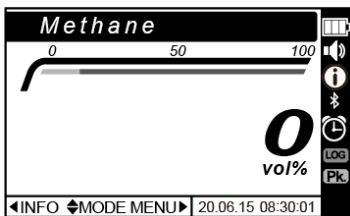

1-gas model

Item	Icon/Display	Ref. page
①	Gas concentration value	17
②	Gas concentration in bar graph form	-
③	Gas alarm set value in bar graph form	-
④	Gas type	-
⑤	Unit of measurement	-
⑥	Battery level indicator	38-40
⑦	Audio volume indicator	31
⑧	Temperature/humidity change indicator	16
⑨	Bluetooth	27
⑩	Timer	20-21
⑪	Stopwatch operation indicator Its icon changes to  when activated	21
⑫	LOG (Logging in progress)	23
⑬	Pk. (Peak-hold on/off)	19
⑭	Guidance	-
⑮	Time	33

1m Gas Sampling Tube (curl cord type)

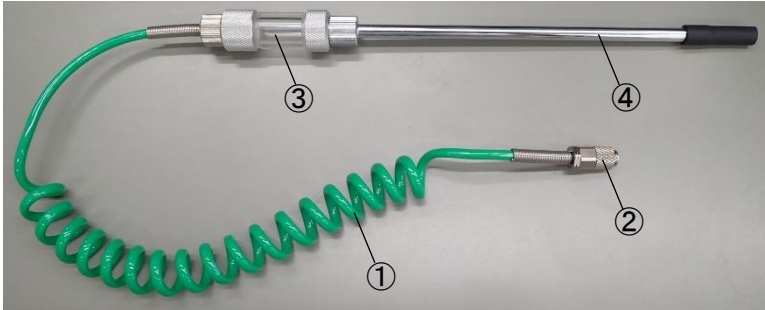

Item	Component	Function
①	Gas sampling tube (1m)	Conveys gas to the gas detector
②	Coupler	Connects to the gas detector
③	Drain filter	Prevents water and dust from entering the gas detector, and houses a filter element (FE-2)
④	Probe nozzle	Extension for the gas suction inlet

Cooling Drain Filter with Cooling Probe Nozzle (only for XP-3380II-E)

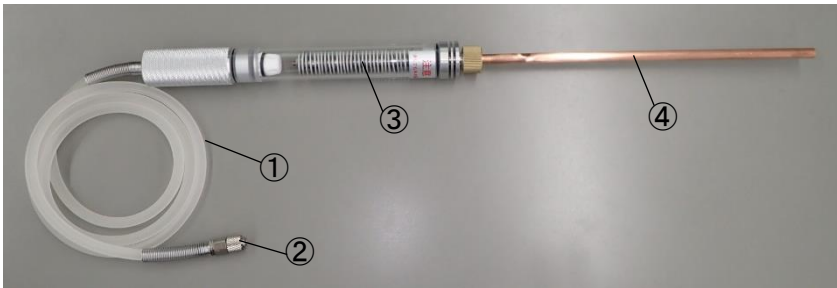

Item	Component	Function
①	Gas sampling tube (1m)	Conveys gas to the gas detector
②	Coupler	Connects to the gas detector
③	Cooling drain filter	Prevents water and dust from entering the gas detector, and houses a filter element (FE-10)
④	Cooling probe nozzle	Extension for the gas suction inlet

Shoulder Strap



Item	Component	Function
①	Shoulder strap	Used to carry a gas detector by looping the shoulder strap over neck or shoulder Consists of two sub-straps connected by a carabiner
②	Loop (2 places)	Connects a shoulder strap to the gas detector There is a loop at the end of each sub-strap

3. Operation

3-1. Preparation

3-1-1. Battery installation

Units are shipped without batteries. Remove the battery cover and then install the four supplied batteries. See "Battery Replacement" on pages 38 to 39 for the procedure. The battery cover is pre-installed when shipped.

3-1-2. 1m gas sampling tube/drain filter/cooling drain filter installation

Connect the coupler of the gas sampling tube drain filter/cooling drain filter to the gas inlet of the gas detector. To remove the coupler from the gas inlet, pull the sleeve up to release.

Install the gas sampling tube's probe nozzle to the sampling tube holder as shown in the right photo.



3-1-3. Shoulder strap installation

(1) Separate the sub-straps from each other by opening the carabiner.



(2) Attach each sub-strap to the detector by threading its loop through the strap hole (2 places) located at the bottom of the detector. *Attach the sub-straps while the detector is installed in the elastomer case.

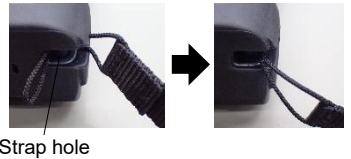

(3) Reassemble the sub-straps into the shoulder strap by closing the carabiner. *The shoulder strap length can be changed with its adjuster.



3-1-4. How to use the stand

Lift the stand up such that the detector can stand alone on the desk, etc. The stand can be opened up to 90°.

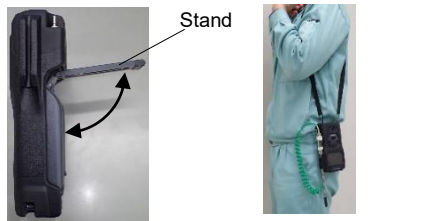

3-2. Operating Procedure



WARNING

- Perform routine check prior to use (page 44).
- If the detector is marked with both temperature classes T3 and T4, before deploying the detector in a hazardous area, the user shall check the battery type via the LCD, and ensure that, if MiMh batteries are fitted, the detector is only used in areas requiring temperature class T3.
- Use of the detector in an atmosphere with greater than 21% of oxygen will compromise the explosion-proof performance of this detector.
- Detector which is marked with temperature class T4 only, shall only fitted with alkaline primary batteries.

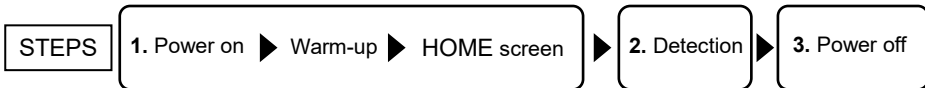

1. Power on -> Warm-up -> HOME screen



WARNING

- Turn on the gas detector with the gas sampling tube (or optional drain filter or cooling drain filter in case of XP-3380II-E) attached, in clean air.
Zero adjustment (20.9% adjustment for oxygen) is automatically done during the powering-up. Ensure that the zero adjustment is done in clean air. Inaccurate gas concentrations will be indicated if the zero adjustment is done in a gas atmosphere.
- Do not use the gas detector without with the gas sampling tube (or optional drain filter or cooling drain filter in case of XP-3380II-E). Proper gas detection is not possible without it.



CAUTION

Even after the HOME screen is displayed, the reading for zero may fluctuate or blink due to an ambient temperature change, etc. For this reason, it is recommended to perform zero adjustment before use.

For the XP-3340II model, the reading may fluctuate or blink due to interfering gas which is present in the atmosphere (e.g., CO₂), but this is not a device failure.

Press and hold the power button until the power-on screen (company logo ) is displayed on the LCD.

--> After the unit beeps once, the “model, serial No. and battery type”, “target gases”, “full scale values”, “alarm set values”, “previous calibration date” and “log memory usage”, and “Bluetooth not available” screens will be displayed in sequence. When the unit gives off a beep, a warm-up cycle will start. The warm-up progress bar will be displayed. When the warm-up cycle is completed, “Warm-up completed 100%” will be displayed and a zero adjustment will be automatically started. When the zero adjustment is completed, the unit will give a long beep and the gas concentrations screen (HOME) will be displayed.

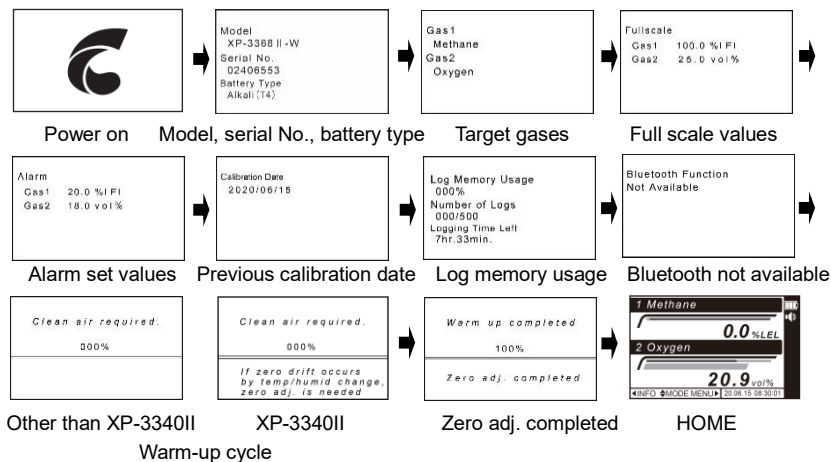
**NOTE**

- Warm-up cycle takes a maximum of 5 minutes.
- Only Gas1 and its information is displayed for a single-gas detector.
- Only the power off button is enabled during warm-up cycle. Operation of other buttons is disabled.
- If an error message appears, see “Error Messages” on pages 36 and 37.
- The previous calibration date screen is skipped when shipped, because there is no record.
- The log memory usage screen is skipped for the unit with no Bluetooth function installed.
- The Bluetooth not available screen is skipped for the unit with Bluetooth function installed.

2. Detection

When the HOME screen is displayed, it means that the detector is ready for use.

--> See "LCD" on page 10.

--> See "HOME Screen" on page 17.

--> See "Gas Alarm Operation" on page 18.

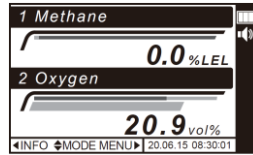

HOME

When the  icon (temperature/humidity change indicator) blinks or when "0" or "0.0" for the gas concentration value blinks, perform zero adjustment in clean air. See page 22.

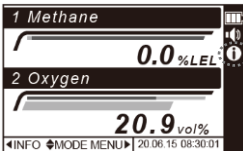

Blinking

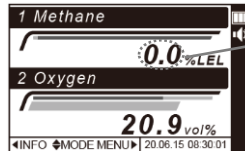

Blinking



WARNING

- Do not block any gas inlet and outlet. If blocked, normal detection is not possible.
- Keep the filter element at the drain filter clean and dry. If the filter element is dirty or wet, proper gas detection is not possible.
- If a reading exceeds the full scale value, move the detector to clean air area immediately. If not moved to clean air and continued to be used, improper gas detection will result, or it may take time for the reading to return to the zero point.
- Do not block the audio opening. If blocked, the audible alarm will be muffled.



CAUTION

The following situation may cause zero drift (0%LEL, 0ppm or 20.9vol% point may drift). In this case, perform zero adjustment in clean air (page 22):

- zero adjustment was performed in a gas atmosphere,
- a significant change in the work environment (e.g., temperature or humidity change) takes place, or
- a high concentration gas was detected.

NOTE

During button operation, "press" means to press the button for less than one second, and "press and hold" means to keep pressing the button for more than two seconds.

3. Power off

Press and hold the power button for four seconds. "POWER OFF" will be displayed. Then, a countdown will begin with "3," "2," and "1" being displayed in sequence along with a beep for each; in the end, three beeps will be heard. The LCD will turn off and then the unit will turn off.

If residual gas remains inside the detector, the pump will automatically run a maximum of 60 seconds after power off.

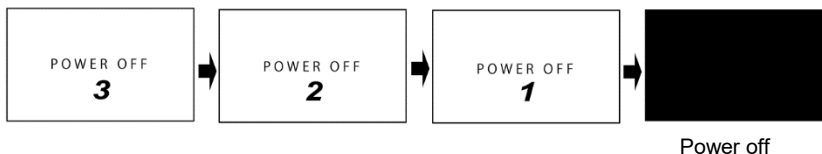

CAUTION If the detector sampled high-humidity air, run the detector in clean air at normal humidity condition for more than 5 minutes before turning it off.

HOME screen (gas concentrations screen)

This detector can simultaneously display one or two gas concentrations on its LCD. For 1-gas models, the gas name and concentration of the single target gas are displayed. (Most diagrams used in this manual use a typical 2-gas model as a sample.)

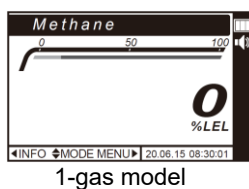
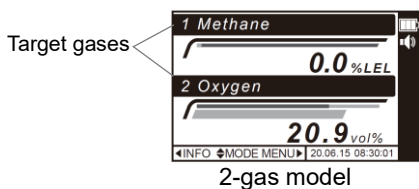

If a gas concentration exceeds the service range, the term "OVER RANGE" will replace the gas concentration value.

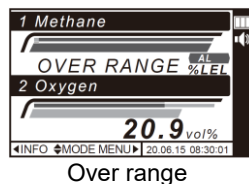

NOTE

- See the next page for the over range conditions.
- See "Specifications" on pages 50 and 51 for the service range.

Gas alarm operation

When the gas concentration exceeds the gas alarm set value, the unit will start beeping, alarm light will start blinking red, "AL" or "ALARM" will appear on the LCD, and the backlight will turn on. When the gas concentration falls below the gas alarm set value, the gas alarm will automatically deactivate (auto-resetting).

NOTE

- Press the ▼ button for two seconds to silence the beeping during an active alarm. However, if a new alarm arises, the unit will start beeping.
- The unit does not beep when the audio level is set to MUTE ( icon is present).

When a high concentration gas is detected and the service range is exceeded, "OVER RANGE" will be displayed instead of the gas concentration value. In this case, move the detector to clean air area immediately and run it. Check that the gas concentration value falls enough and residue gas is removed from the unit, and then turn it off. Exposure to high concentration gas may impair the sensor performance.

Example: Typical alarm setting for a methane and oxygen detector

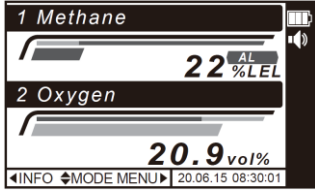
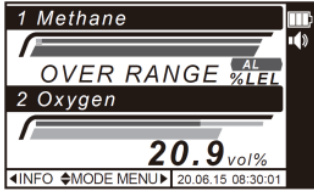
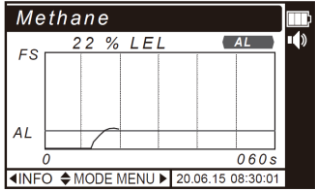
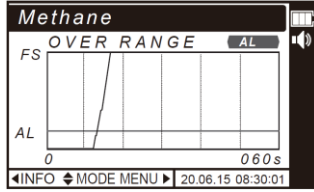
		Gas alarm	Over range alarm
Gas type	Combustible gas	20%LEL	110.1%LEL ≥
	Oxygen	18.0vol%	50.1vol% ≥
Alarm sound		Beeping	Beeping
Alarm light		Blinks red at 0.25 sec intervals	Blinks red at 0.25 sec intervals
LCD	Standard display	<p>"AL" displayed "ALARM" displayed for 1-gas model</p> 	<p>"OVER RANGE" displayed</p> 
	Trend graph display	<p>"AL" displayed</p> 	<p>"OVER RANGE" displayed</p> 

3-3. Functions in Normal Operation

This section describes functions available during normal operation through button operation. “Normal operation” is a status in which the detector is capable of gas monitoring/detection after powering-up, and normally the gas concentrations screen (HOME) is displayed on the LCD.

NOTE

During normal operation, the unit keeps monitoring the gas concentrations even when the HOME screen is not displayed on the LCD and an alarm will be activated when the gas concentration reaches the alarm set value.

During normal operation, press the ▼ button to cycle through the following options. Pressing the ▲ button cycles through in the reverse direction.

3-3-1. Peak hold on/off

3-3-2. Trend graph display

3-3-3. Timer

3-3-4. Stopwatch

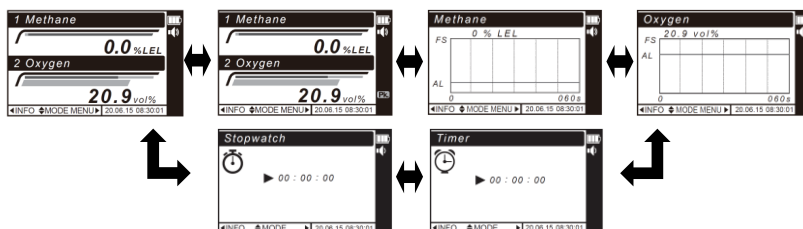

3-3-1. Peak hold on/off

- (1) During normal operation, press the ▼ button to display the “Pk.” icon on the right side of the LCD. Now the peak hold function is active. If the highest concentration (lowest for oxygen) is detected, it will replace the current peak value. The new peak value will be maintained on the LCD until exceeded. The peak value in bar graph form will be also maintained until exceeded.
- (2) To deactivate the peak hold function, press the ▲/▼ button. The “Pk.” icon will disappear, the peak value will be reset, and the LCD will then return to the HOME screen.

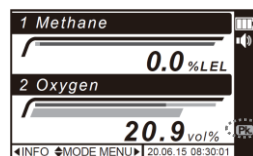

NOTE

- The peak hold function will be canceled each time the unit is turned off or the screen moves to a different screen.
- Once the peak hold function is activated, the new peak value will be updated and maintained on the LCD, even if the actual gas concentration falls below that value (or below that value for oxygen).
- When the gas concentration return to the normal level, the alarm light will automatically stop blinking and the unit will stop beeping.

3-3-2. Trend graph display

- (1) During normal operation, use the ▲/▼ button to display the gas concentration trend for the last one to five minutes' span in a graph form.

NOTE

- Select the time span by referring to “Trend graph span setting” on page 28.
- If a gas alarm is activated for one of the target gases (GAS1 or GAS2) while a trend graph for the other gas is on the screen, a popup message for the gas alarm will appear. To hide the message, press the ▼ button for two seconds.

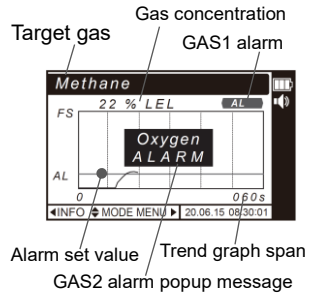

3-3-3. Timer

- (1) During normal operation, use the ▲/▼ button to go to the timer screen. Use the ◀/▶ button to move the cursor between hours, minutes, and seconds. Set the time-out value for each by using the ▲/▼ button.

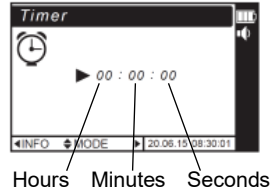

- (2) Press the ▶ button to confirm the setting. “START” will appear on the LCD.



- (3) Press the ▶ button to start the countdown. The timer icon will appear on the right side of the LCD. When the timer times out, the timer icon will start blinking and the unit will start beeping. To clear the blinking icon and beeping, press any button.

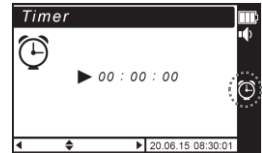

NOTE

The unit does not beep when the audio level is set to MUTE.

- (4) To pause the countdown, press the ▶ button, while “PAUSE” is displayed on the LCD. The countdown will be paused and “RESUME” will be displayed on the LCD.

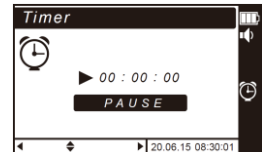

- (5) To resume the countdown, press the ▶ button, while “RESUME” is displayed.

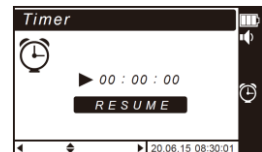

- (6) To reset the countdown, press the ▲/▼ button to display “CLEAR”, and then press the ► button for confirmation.

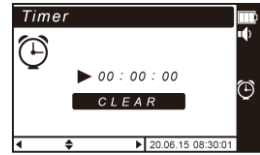

NOTE

If the LCD returns to the HOME screen while the timer is active, the timer icon and the countdown will be displayed on the right and bottom respectively.

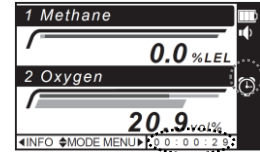

3-3-4. Stopwatch

- (1) During normal operation, use the ▲/▼ button to go to the stopwatch screen.
- (2) Press the ► button for confirmation. “START” will appear on the LCD. Press the ► button to start the countup.
- (3) To pause the countup, press the ► button, while “PAUSE” is displayed on the LCD. The countup will be paused and “RESUME” will be displayed on the LCD.
- (4) To resume the countup, press the ► button, while “RESUME” is displayed.
- (5) To reset the countup, press the ▲/▼ button to display “CLEAR”, and then press the ► button for confirmation.

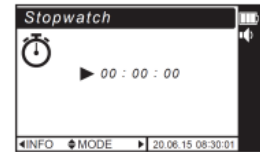

Stopwatch screen

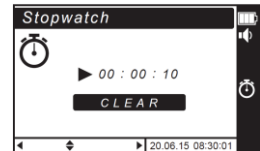
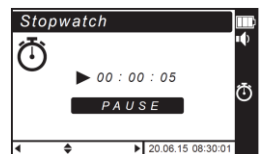

NOTE

If the LCD returns to the HOME screen while the stopwatch is active, the stopwatch icon and the countup will be displayed on the right and bottom respectively.

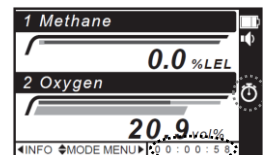

3-3-5. Zero adjustment (zeroing)

⚠ WARNING Perform zero adjustment in clean air. Inaccurate gas concentrations will be indicated if zero adjustment is done in a gas atmosphere.

During normal operation, press and hold the ◀ button for four seconds to start zero adjustment.

--> "ZERO ADJUST" will be displayed. A countdown will begin with "3," "2," and "1" being displayed in sequence along with a beep for each. When the zero adjustment is complete, there will be a long beep with "ZERO ADJUST COMPLETED" being displayed, and then "0.0%LEL" or "0ppm" for combustible gas and "20.9vol%" for oxygen will be displayed.

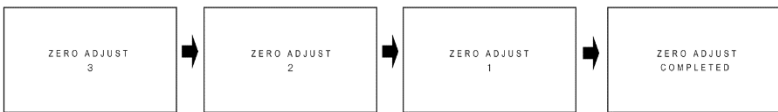

3-3-6. Display device information

During normal operation, press the ◀ button to display the device information.

--> Pressing the ▼ button cycles through the below information.

Pressing the ▲ button does the same in the reverse direction.

1. Model, serial number, and battery type
2. Target gases
3. Full scale values
4. Alarm set values
5. Previous calibration date
6. Log memory usage, number of logs, and logging time left
7. Bluetooth not available

To return to the HOME screen, press the ▶ button.

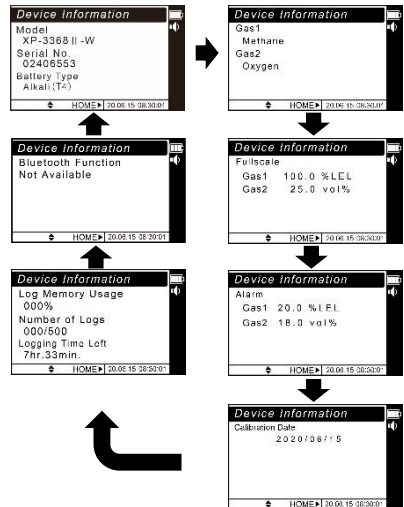

NOTE

- Gas2 and its information are not displayed for 1-gas models.
- The previous calibration date screen is skipped when shipped, because there is no record.
- The log memory usage screen is skipped for the unit with no Bluetooth function installed.
- The Bluetooth not available screen is skipped for the unit with Bluetooth function installed.

3-3-7. LCD backlight and flashlight on/off

- (1) Press and hold the ▲ button. The LCD backlight will turn on with a long beep.
- (2) Press and hold the ▲ button again. The flashlight will turn on with a long beep.
- (3) Press and hold the ▲ button again. The LCD backlight and flashlight will both turn off with a long beep.

NOTE

- The LCD backlight will automatically turn on when a gas alarm goes off, and then it will automatically turn off when the gas alarm is cleared. Also, pressing any button will turn on the LCD backlight, which will automatically turn off 5 seconds later if left idle.
- The unit does not beep when the audio level is set to MUTE.

3-3-8. Return to HOME screen

To return to the HOME screen, press the power button. This function is disabled in the trend graph display mode and while the peak hold is active, except for oxygen detection.

3-3-9. Change unit of measurement (only for XP-3360II-W and XP-3368II-W)

Pressing the power button while on the HOME screen changes the unit of measurement between “%LEL” and “ppm”. It can be also changed in the trend graph display mode and while the peak hold is active.

NOTE

The unit of measurement setting will be retained even after the unit is turned off or the batteries are removed.

3-3-10. Data logging (for the unit with Bluetooth function installed)

- (1) Press and hold the ► button. The unit will give off a long beep and “LOG” icon will appear on the right side of the LCD. The logging of the measured concentrations, temperatures and humidities will start.
- (2) To end the logging, press and hold the ► button. The unit will give off a long beep and “LOG” icon will disappear. The logging will end.

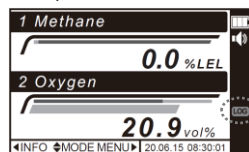

Data logging is in progress

NOTE

- To change the logging interval rate, to turn the logging on/off or delete logs, see (E) “Logging interval rate setting, logging on/off, and log deletion” on pages 28 to 30.

3-3-11. Mute audio gas alarm

Pressing and holding the ▼ button when a gas alarm is active, mutes the audio alarm.

3-4. Settings

From the Setup Menu screen, it is possible to change the target gas; convert to other gas's concentration; turn on/off Bluetooth; set the time span for trend graph display; set logging interval rate; turn on/off logging; delete logs; adjust the audio volume; set the alarm set value; perform an alarm test; adjust the clock; and select the language.

Setup item	Function and setting	Ref. page
Change target gas	Changes (selects) the target gas * ¹	26
Convert to other gas's concentration	Calculates and displays other gas concentration (estimation) * ²	26-27
Bluetooth on/off	Sets the Bluetooth to on/off* ⁴ For connectable devices, see * ³	27
Trend graph span setting	Sets the trend graph's time span to display on the LCD Settable span is 1, 2, 3, 4, or 5 minutes.	28
Logging interval rate setting, logging on/off, and log deletion	Sets the logging interval rate* ⁴ Sets the data logging to on/off* ⁴ Deletes all the logs * ⁴	28-30
Audio volume control	Adjusts the audio level (gas alarm sound, fault alarm sound and button tone)	31
Alarm set value setting and alarm test	Sets the alarm set value Checks an alarm operation (alarm light and sound) by simulating a gas alarm condition.	32-33
Clock adjustment	Adjusts the current time	33
Language selection	Selects the language to display, between Japanese and English	33

*1. The target gas can be changed (selected) if the unit is a model capable of detecting more than one combustible gas.

*2. The mode is enabled only with XP-3310II, XP-3318II, XP-3360II-W, and XP-3368II-W units, in which GAS1 (target gas) is set to methane, isobutane, or propane. See "Convertible Gas List" on page 27 for the 32 convertible gas options.

*3. It is possible to view log data as well as real-time measurement data, etc., in a graph form by using an Android (ver. 7.0 or higher) or iOS (ver. 10.0 or higher) device with built-in Bluetooth. To do this, download a free app "Utility for gas detector" from the Google Play or App store.

It is also possible to read out log data from the detector in a graph form/CSV format, by using a PC (Windows 8.1 and 10) and a data logger software (XP-3000IIL, separately sold). For the readout procedure, see the data logger software's instruction manual.

*4. Settable for the unit with Bluetooth function installed.

3-4-1. Go to setup menu

Press the ► button while on the HOME screen. “Set Up” is highlighted in blue (selected). Then press the ► button to confirm the selection. The “Setup Menu” screen will be displayed.

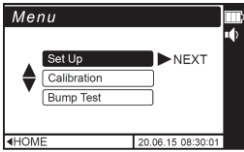

“Set Up” highlighted in blue

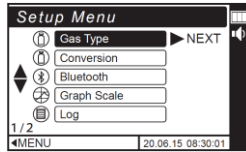

Setup Menu

NOTE

When the conversion mode is active, pressing the ► button while on the HOME screen skips the “Menu” and directly goes to the “Setup Menu” screen.

3-4-2. Enter setup mode

From the Setup Menu screen, select the desired setup mode with the ▲/▼ button. Then press the ► button to confirm the selection.

--> The unit goes off a beep and then enters the selected mode.

See the table on the previous page for information on the setup modes.

3-4-3. Exit setup mode

While in any setup mode, each press of the ◀ button returns to the previous step.

NOTE

Pressing the power button returns to the HOME screen.

3-4-4. Operation procedure in each setup mode

Basic button operation is as follows:

- Select the option: Press the ▲ or ▼ button.
- Confirm your selection/setting: Press the ► button.
- Return to the previous step: Press the ◀ button.

(A) Change target gas

NOTE

- The target gas can be changed (selected) if the unit is a model capable of detecting more than one combustible gas.
- The set details in this mode will be saved even after the unit is turned off or the batteries are removed.

While on the Setup Menu screen, use the ▲/▼ button to select “Gas Type”. Then press the ► button to confirm the selection. Once this step has been completed, a list of target gas options will be displayed.

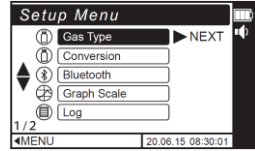

Setup Menu

Use the ▲/▼ button to select the desired target gas from the list. Then press the ► button to confirm the selection.

On the HOME screen, the name of the gas type will be replaced by the selected one's.

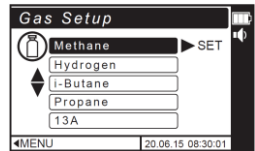

Gas Setup

(B) Convert to other gas's concentration (conversion mode)

**CAUTION**

- A converted (calculated) gas concentration is only an estimate and no guarantee is provided.
- The detection of some gas types requires a gas sampling tube for solvent gas detection (SH-401, separately sold). When such a gas type is selected, a special instruction will be displayed accordingly on the LCD.

NOTE

- The conversion mode is enabled only with XP-3310II, XP-3318II, XP-3360II-W, and XP-3368II-W units, in which GAS1 (target gas) is set to methane, isobutane, or propane. See the “Convertible Gas List” on the next page for the 32 convertible gas options.
- The “Conversion” option is not displayed (not settable) on the Setup Menu screen, when GAS1 is set to an option other than methane, isobutane or propane.
- To exit the conversion mode, go to the “Convert to other conc.” screen then return the gas type to the original one, or turn off the detector.
- The gas types set for the target gases are not included in the list of convertible gas options shown on the “Convert to other conc.” screen.
- The set details in this mode will not be saved after the unit is turned off or the batteries are removed.

While on the Setup Menu screen, use the ▲/▼ button to select “Conversion”. Then press the ► button to confirm the selection. Once this step has been completed, a list of convertible gas options will be displayed.

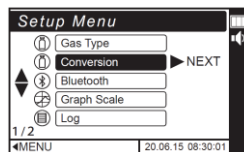

Use the ▲/▼ button to select the desired gas type from the list. Then press the ► button to confirm the selection.

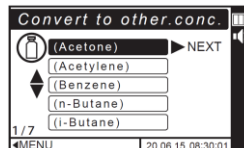

Convertible Gas List						
Acetone*	Cyclohexane*	Ethylacetate*	n-Hexane*	Methanol*	Propane	Toluene*
Acetylene	Cyclopentane*	Ethylbenzene*	Hydrogen	Methylcyclohexane*	Propylacetate*	o-Xylene*
Benzene*	DME	Ethylene	IPA*	MIBK*	Propylene	m-Xylene*
n-Butane	Ethane	Gasoline*	MEK*	n-Pentane*	THF*	p-Xylene*
i-Butane	Ethanol*	n-Heptane*	Methane			

Note that the name of the replacement gas type will be displayed in brackets. E.g. (Methane)
 * The detection for these gas types require a gas sampling tube for solvent gas detection (SH-401, separately sold).

(C) Bluetooth on/off

NOTE

Bluetooth can be turned on/off for the unit with Bluetooth function installed.

While on the Setup Menu screen, use the ▲/▼ button to select “Bluetooth”. Then press the ► button to confirm the selection.

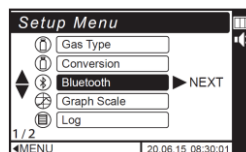

Select “ON” or “OFF” with the ▲/▼ button. Then press the ► button to confirm the selection.

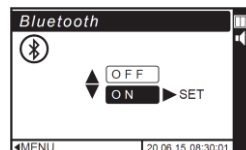

When set to “ON”, pairing with other Bluetooth devices (e.g., PC, cellphone) is possible. The Bluetooth icon lights up on the right side while Bluetooth is active.

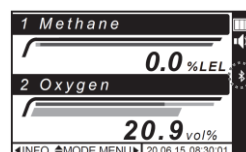

Bluetooth icon

(D) Trend graph span setting

While on the Setup Menu screen, use the ▲/▼ button to select “Graph Scale”. Then press the ► button to confirm the selection.

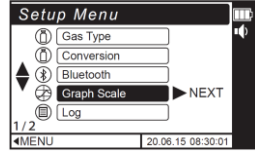

Set the span to the desired value with the ▲/▼ button. Then press the ► button to confirm the setting. The settable value is 1, 2, 3, 4, or 5 minutes.

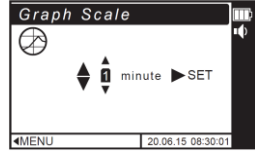

The trend graph shows the gas concentrations measured for the past set period. The set value will be displayed at the bottom-right corner.

Settable value	Set value displayed at bottom-right corner
1 minute	060s
2 minutes	120s
3 minutes	180s
4 minutes	240s
5 minutes	300s

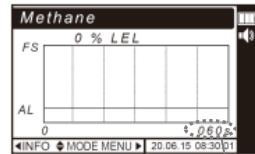

Trend graph display
Set value

(E) Logging interval rate setting, logging on/off, and log deletion

NOTE

Data logging related options are not settable for the unit with no Bluetooth function installed.

(E-1) Logging interval rate

While on the Setup Menu screen, use the ▲/▼ button to select “Log”. Then press the ► button to confirm the selection.

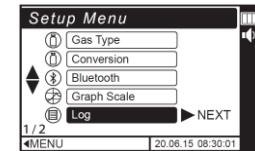

Select “Log Interval”, then press the ► button to confirm the selection.

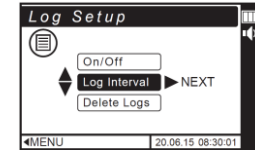

Set the logging interval rate to the desired value with the ▲/▼ button. Then press the ► button to confirm the setting. The settable range is 1 to 255.

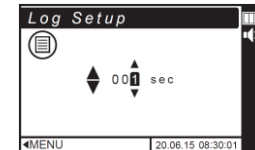

Select the unit of measurement for the logging interval rate with the ▲/▼ button. Then press the ► button to confirm the selection. The settable unit is “00ms”, “sec”, “0sec”, “min”, “0min” or “hour”.

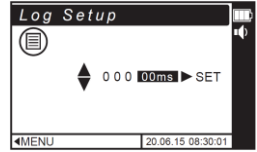

(E-2) Logging on/off

To start (or end) data logging, select “On/Off” on the Log Setup screen. Press the ► button to confirm the selection.

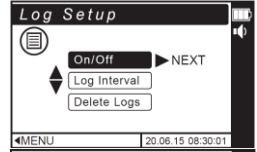

Select “ON” (or “OFF”) with the ▲/▼ button, and then press the ► button to confirm the selection.

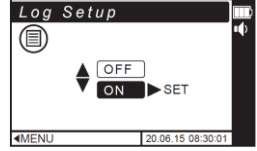

When “ON” is selected, the “LOG” icon will be displayed on the right side, and then the gas concentrations are logged (the measured temperatures and humidities are also logged and they are only an estimate and no guarantee is provided).

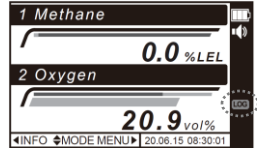

Logging is in progress

(E-3) Log deletion

To delete the logs, select “Delete Logs” on the Log Setup screen. Press the ► button to confirm the selection.

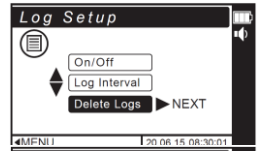

Select “YES” with the ▲/▼ button, and then press the ► button to confirm the selection. All the logs will be deleted.

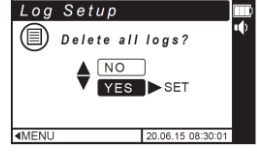

NOTE

It is possible to view the log memory usage (used %), number of logs, and logging time left (the time remaining before the logging stops) from the device information display (page 22).

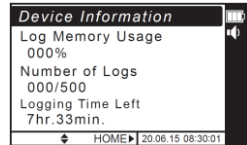

NOTE

- The factory default of the logging interval rate is one second. The minimum settable interval rate is 200 ms.
- The logging period is approx. 40 hours when the logging interval rate is set to 10 seconds for 2-gas models. It is approx. 70 hours for 1-gas models.
- Up to 500 log files can be saved; more than 500 files cannot be saved even if free space is available.
- If the device clock is inaccurate, accurate logging is not possible. Adjust the clock. (Clock adjustment on page 33)
- Logging will automatically stop if:
 - the detector powers off (logged data will be automatically saved),
 - log memory usage (used space) reaches 100%, or
 - an error occurs, except for a pump error (logging will continue even when a pump error occurs).
- Log data readout requires a PC + a data logger software (XP-3000IIL, separately sold) or an Android (ver. 7.0 or higher) or iOS (ver. 10.0 or higher) device with built-in Bluetooth. For the readout procedure, see the data logger software's instruction manual or follow the instructions in the free app "Utility for gas detector".
- If the power is interrupted for a few seconds (e.g., by the detector being bumped or dropped) while logging, the logs collected one minute before the interruption will not be saved.
- The logged gas concentrations within the full-scale range (not service range) can be viewed on a cell phone or PC.

(F) Audio volume control

⚠ WARNING

- The factory default for audio volume level is medium.
- The change of audio level should be performed by the safety supervisor. When the level is changed, perform an alarm test (page 33) to check the audio level.
- The audio volume setting will be retained even after the unit is turned off or the batteries are removed.
- The unit does not beep when the audio level is set to MUTE. (The unit will give two beeps if an error occurs even when the audio level is set to MUTE.)

While on the Setup Menu screen, use the ▲/▼ button to select “Audio Volume”. Then press the ► button to confirm the selection.

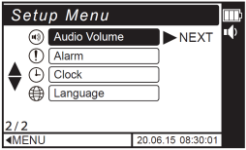

Set the volume to one of the four levels, max, medium, small and mute, with the ▲/▼ button.

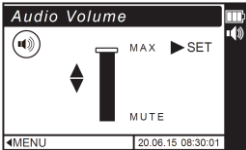

Max

NOTE Volume indicator icon on the right side will change in accordance with the set level.

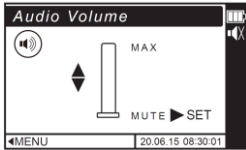

Mute

(G) Alarm set value setting and alarm test

(G-1) Alarm set value



WARNING

Setting of the alarm set value is very important. The alarm set value should be changed by the safety supervisor.

While on the Setup Menu screen, use the ▲/▼ button to select “Alarm”. Then press the ► button to confirm the selection.

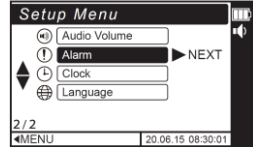

To change the alarm set value, select “Set Value” with the ▲/▼ button. Then press the ► button to confirm the selection. The password entry screen will appear.

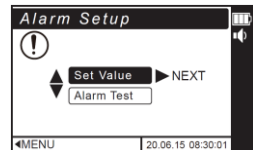

Enter the password “822” with the ▲/▼ button.

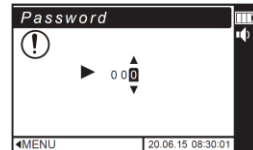

Select “GAS1” or “GAS2” with the ▲/▼ button. Then press the ► button to confirm the selection.

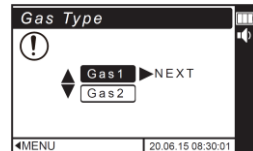

Set the alarm set value for GAS1 or GAS2 with the ▲/▼ button. Then press the ► button to confirm the setting.

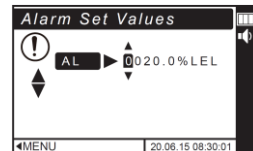

(G-2) Alarm test

To perform an alarm test, select “Alarm Test” on the “Alarm Setup” screen with the ▲/▼ button, and then press the ► button. “ALARM” will be displayed.

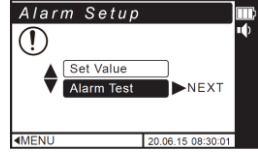

Press the ► button to start the test. The unit will start beeping with red-blinking alarm light (a gas alarm is simulated).

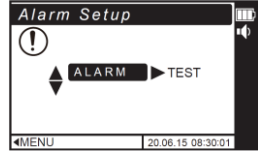

To end the test, press the ◀ button.

NOTE

- The unit does not beep when the audio level is set to MUTE.
- Pressing and holding the ▼ button while during the alarm test does not mute an audio alarm.

(H) Clock adjustment



WARNING

Do not set a date which does not exist on the calendar. Such date will contradict the log data.

While on the Setup Menu screen, use the ▲/▼ button to select “Clock”. Then press the ► button to confirm the selection.

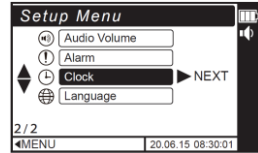

Pressing the ▲/▼ button increases/decreases the value for each item (year, month, day, hour, and minute).

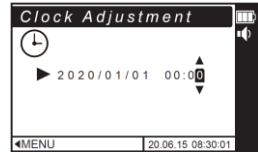

Adjust each item, and then press the ► button to confirm the set values (present date and time).

(I) Language selection

While on the Setup Menu screen, use the ▲/▼ button to select “Language”. Then press the ► button to confirm the selection.

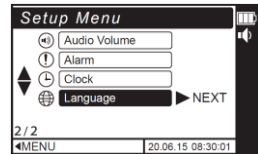

Use the ▲/▼ button to select “日本語” (Japanese) or “ENGLISH”. Then press the ► button to confirm the selection.

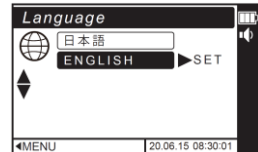

3-5. Span Adjustment

Span adjustment is enabled only with XP-3310II, XP-3318II, XP-3360II-W, and XP-3368II-W units, in which GAS1 (target gas) is set to methane, isobutane, hydrogen, or propane.

Perform a zero adjustment (page 22) before a span adjustment.

Go to the span adjustment mode and then perform a span adjustment

- (1) Press the ► button while on the HOME screen to go to the Menu. Select “Calibration” with the ▲/▼ button. Then press the ► button to confirm the selection.

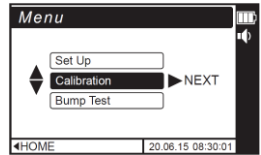

- (2) Set the value to the target span value (span gas's concentration) with the ▲/▼ button. Then press the ► button to confirm the setting.

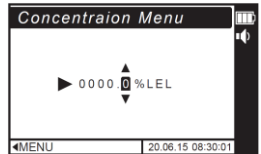

NOTE The settable span is from 30 to 100%LEL.

- (3) Let the detector sample the span gas for more than one minute. Then press the ► button to start a span adjustment.
- (4) A successfully completed span adjustment displays “COMPLETED”.

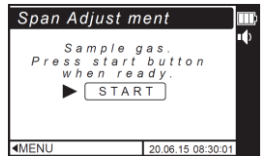

If “FAILED” is displayed, the target span value may be incorrect. Check that the target span value is correct.

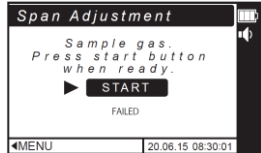

3-6. Bump Test

Bump test is to check that the reading falls within the normal range by using the actual test gas and optional EG-129 bump tester.

Go to the bump test mode and then perform a bump test

- (1) Press the ► button while on the HOME screen to go to the Menu. Select “Bump Test” with the ▲/▼ button. Then press the ► button to confirm the selection.
- (2) Connect the bump tester to the detector (see the EG-129 bump tester’s instruction manual for test setup). While keeping the detector sampling the test gas, press the ► button to start a bump test.
- (3) A completed test displays a test result, “PASSED” or “FAILED”.

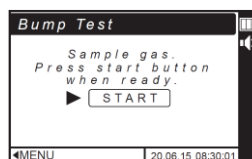
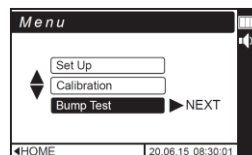

NOTE

- Bump tester is intended only for XP-3310II, XP-3318II, XP-3360II-W and XP-3368II-W units in which GAS1 (target gas) is set to methane, isobutane, hydrogen or propane. See the EG-129 bump tester’s instruction manual for more information on bump test.
- The Menu screen is not displayed while in the conversion mode, which will then disable to select “Bump Test”. Exit the conversion mode before performing a bump test.

4. Error Messages

If an error occurs in the detector, the corresponding error message will be displayed on the LCD, the unit will beep, and the alarm light will blink yellow. (The unit will give two beeps instead of beeping constantly, if a device error occurs when the audio level is set to MUTE.) The table below lists the major error messages. If an error occurs, check the cause of the error and take necessary actions. When no error message is displayed but the button or display does not function, remove the batteries, reinstall them, and turn the unit on again. If the unit does not reset to normal, contact New Cosmos or your New Cosmos representative for repair.

Error message table

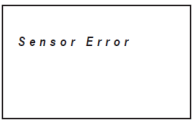
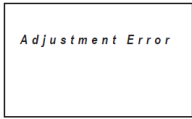
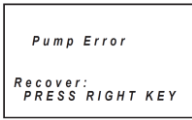
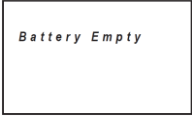
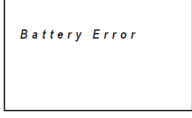
Error message on screen	Error condition	Possible cause	Action
	Sensor error	Sensor installed incorrectly	Check whether the sensor is installed correctly. If the error occurs while the sensor is correctly installed, contact us for repair/sensor replacement.
	Adjustment error	Gas was present when the detector was turned on	If the error occurs at powering-up, turn the unit off and then turn it on in clean air. If the unit does not reset to normal after that, contact us for repair.
	Pump error	Possible water intake, which cause the gas inlet to be blocked, or the sampling tube may be folded	Remove water. (See "Filter Element Replacement" on pages 40-41.) Press the ► (restore pump operation) button. If the error code is still present, the pump may be broken or water or contaminants (e.g., dust) might have entered inside the detector. In this case, contact us for repair.
	Battery depleted	Battery may be low or drained	This is not a failure. Replace/charge batteries. (See "Battery Replacement" and "Charge Batteries" on pages 38-40)
	Battery failure	Old and new batteries may be used together	Replace all the four batteries with new ones. (See "Battery Replacement" on pages 38-39)

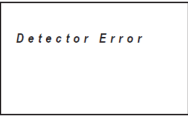
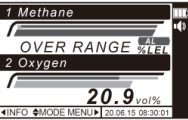
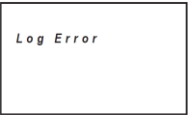
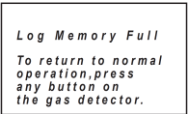
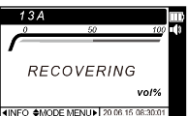
Error message on screen	Error condition	Possible cause	Action
 <p><i>Detector Error</i></p>	<p>Detector error</p>	<p>Detector may be broken</p>	<p>Remove the batteries, reinstall them, and turn on the unit. If the unit does not reset to normal, contact us for repair.</p>
		<p>Alarm may activate while log data is being read out</p>	<p>Turn off the unit, and then turn it on again. Perform log readout in clean air.</p>
 <p>*The alarm light may blink red during the over range condition, because the upper limit of the service range is usually above the alarm set value</p>	<p>Over-range condition</p> <p>The gas concentration value is replaced by the term "OVER RANGE" for the corresponding gas</p>	<p>The upper limit of the service range is exceeded</p>	<p>This is not a failure. The display will return to normal (return to HOME screen), if the gas concentration falls below the upper limit.</p> <p>If "OVER RANGE" is displayed while in clean air, contact us for repair.</p>
 <p><i>Log Error</i></p>	<p>Log error</p>	<p>Log data cannot be saved correctly</p>	<p>Contact us for repair.</p>
 <p><i>Log Memory Full</i></p> <p><i>To return to normal operation, press any button on the gas detector.</i></p>	<p>Log memory full</p>	<p>Data log capacity is full</p>	<p>Delete the log data. For the deletion procedure, see E-3 "Log deletion" on page 29.</p> <p>Pressing or holding any button while "Log Memory Full" is displayed returns the screen to the previous screen.</p>
 <p><i>RECOVERING</i></p> <p><i>vol%</i></p>	<p>Recovering</p>	<p>Impact to the product by dropping or bumping may cause a temporary battery voltage sag</p>	<p>Wait for 10 seconds for recovery.</p>

5. Consumable Replacement

Battery Replacement



WARNING

- Do not replace the batteries in a hazardous area.
- Only use specified batteries below. Using batteries other than those specified may impair the product's explosion-proof performance.
 - Non-rechargeable batteries: Toshiba alkaline AA battery LR6, Panasonic alkaline AA battery LR6X, Duracell alkaline AA battery MN1500, Energizer alkaline AA battery E91, or Varta alkaline AA battery 4106
 - Rechargeable batteries: New Cosmos nickel metal hydride AA battery HR-3UTG
- Remove contaminants from the joint surface between the detector and battery cover. Contaminants such as dust and dirt may cause water ingress into the detector.
- Remove moist and contaminants from the unit before opening the battery cover. Entry of water or contaminants such as dust inside the detector may cause a failure.

NOTE

- Only use new batteries of the same type for replacement.
- Replace all the four batteries at the same time.
- If  is displayed, it is recommended to replace the batteries before they become empty. When using rechargeable batteries, charge them with a dedicated charger (BC-10, separately sold).
- When used at low temperature, the battery life will be shorter than when used at room temperature due to the battery's characteristics. If the battery level is low, it is recommended to replace the batteries before they become empty. When using rechargeable batteries, charge them with a dedicated charger (BC-10, separately sold).

The user can estimate the timing of battery replacement by checking the battery level indicator on the LCD. When the battery is drained, "Battery Empty" will be displayed on the LCD, the unit will beep, and the detector will not detect gases any longer. The LCD will then turn off when the batteries are completely drained.



- (1) Press the power button for four seconds to turn off the detector.
- (2) Rotate the battery cover lock (screw) counterclockwise with a Phillips screwdriver to unlock. The battery cover will slowly come up. Pull and free the cover.
- (3) Replace the old batteries with new ones by referring to the marking.

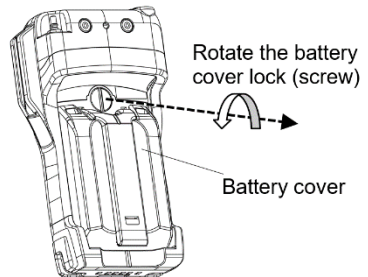

- (4) Install the battery cover. Rotate the battery cover lock (screw) clockwise until it is tight (until the head of the screw is flush with the battery cover surface) with a Phillips screwdriver.

**CAUTION**

Firmly tighten the battery cover lock. Loose battery cover lock may impair the product's explosionproof/waterproof performance.

NOTE

If the battery level is still low even after battery replacement, remove the batteries, and reinstall them.

Charge Batteries

**WARNING**

- Do not charge the batteries in a hazardous area.
- Do not charge the batteries at a place where temperature/humidity may exceed the range 0 to +40°C/0 to 85%RH (no condensation or sudden change in temperature or humidity).
- To charge the batteries, use a dedicated charger (BC-10, separately sold). Also, read the instruction manual for the charger.
- Only use specified nickel metal hydride AA batteries (New Cosmos HR-3UTG). Using batteries other than those specified may impair the product's explosion-proof performance.
- Ensure that all the four batteries have the same serial number.
- Remove contaminants from the joint surfaces between the main unit and battery cover. Contaminants such as dirt may cause water ingress into the detector.
- Clean the charging terminal with a dry cotton swab, if dirty. Be careful not to damage the terminal while cleaning. A damaged or contaminated terminal may cause insufficient battery charge, resulting in shorter continuous operation time.
- The detector must only be charged in a non-hazardous area using the manufacturer's charger type BC-10 (with $U_m = 60\text{ V}$) and in an ambient temperature range of 0 to +40°C. If the detector is marked for use with T3 only or both T3 and T4, the user shall check the battery type before charging and only attempt to charge the detector if it contains NiMH batteries. Detector marked T4 only, shall not be recharged.

NOTE

- Battery charging may take longer if the batteries have been left unused for an extended period of time.
- When used at low temperature, the battery life will be shorter than when used at room temperature due to the battery's characteristics. If the battery level is low, it is recommended to charge the batteries before they become empty.
- Rechargeable batteries deteriorate after repeated charge/discharge cycles, which reduces the battery life. Replace the batteries if continuous operation time becomes extremely short, indicating the end of the battery life.
- If  is displayed, it is recommended to charge the batteries before they become empty.

The user can estimate the timing of battery recharging by checking the battery level indicator on the LCD. When the battery is drained, "Battery Empty" will be displayed on the LCD, the unit will beep, and the detector will not detect gases any longer. The LCD will then turn off when the batteries are completely drained.

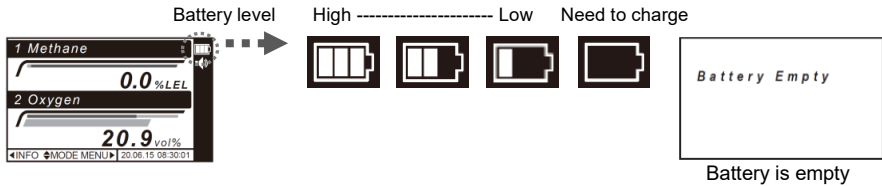

Filter Element Replacement

Replace the filter element with a new one if it is dirty or wet. If water is present inside the drain filter or filter case, remove the water and clean the drain filter or filter case.



WARNING

- Do not replace the filter element while the detector is in operation, to prevent foreign matter (e.g., dust, sand) from entering inside the unit.
- Ensure that the filter element is installed correctly. Misalignment may compromise gas detection and waterproof performance.
- Call for repair if water is observed to be inside. Proper gas detection is not possible if water is present inside the gas detector.

NOTE

Do not push or poke the filter element with a finger etc. Deformation or breakage of the filter element may compromise its waterproof function.

Replace the filter element for the drain filter

- (1) Separate the filter case from the drain filter by turning the case counterclockwise.
- (2) Remove the gasket (O-ring) from the filter case by using a small screwdriver etc.
- (3) Replace the filter element (FE-2) with a new one.
- (4) Reinstall the filter case to the drain filter.

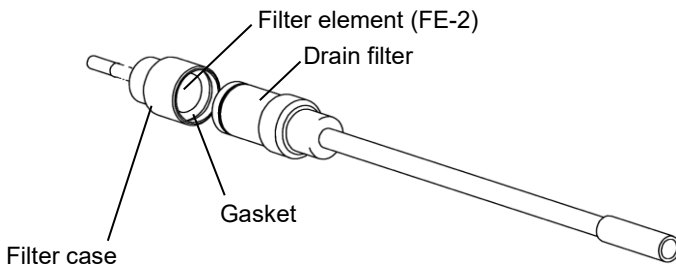

Replace the filter element for the cooling drain filter (only for XP-3380II-E)

- (1) Pull and separate the drain cup from the cooling drain filter.
- (2) Remove the gasket (O-ring) from the drain cup by using a small screwdriver etc.
- (3) Replace the filter element (FE-10) with a new one.
Wrap the new filter element around the metal tip of the drain cup, and secure it in place with the gasket.
- (4) Reinstall the drain cup to the drain filter.

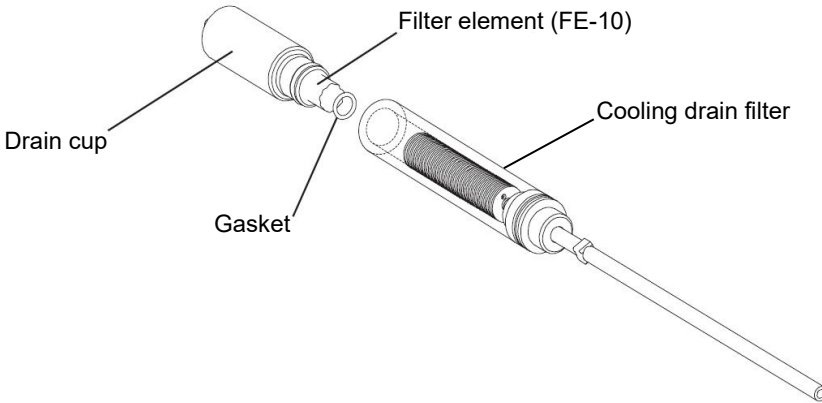

■ Sensor Replacement (oxygen sensor)

- ⚠ WARNING**
- Before opening any part of the gas detector or sensor replacement, ensure no explosive atmospheres are present.
 - Do not replace the sensor in a hazardous area.
 - Only use specified sensors. Only use a New Cosmos Electric Co., Ltd manufactured sensor, and ensure that the sensor has correct part number.
 - During sensor replacement, be careful not to damage, contaminate, or spill any substance on the gas detector. Damaged or contaminated circuit, components, or wiring may compromise the intrinsic safety of the product and increase the risk of explosion.
 - Do not remove or disassemble components other than instructed to do so in the manual.

- ⚠ CAUTION**
- Normal gas detection is not possible if the gasket is missing or installed incorrectly.
 - Handle the sensor with care. Do not drop or throw it.
 - Do not install other than the target gas's sensor into the XP-3310II, XP-3360II, XP-3360II-W, XP-3380II, or XP-3380II-E unit.

- (1) Ensure that the gas detector is off. Remove the gas sampling tube (or attachment) from the gas detector. Remove the shoulder strap and the elastomer case from the gas detector.

Elastomer case

NOTE

Remove the elastomer case by peeling it from the bottom as shown in the drawing.

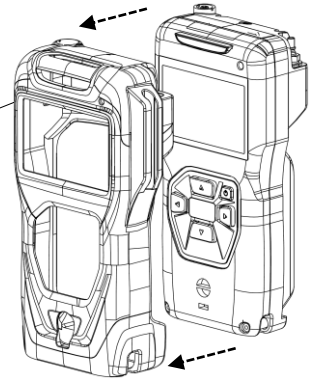
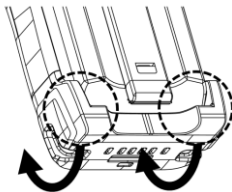

- (2) Remove the four screws from the back cover. Carefully and slowly remove the back cover. Keep the detector in its current orientation and do not turn it upside down, which may cause the oxygen sensor to fall out. Take care not to lose the removed screws.

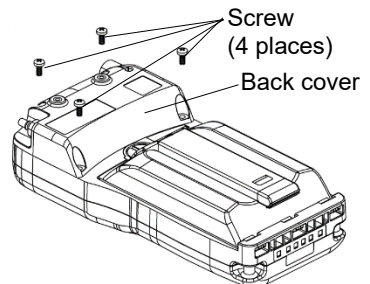

- (3) Remove the sensor spacer. Pinch the head of the oxygen sensor and slowly lift and remove it from the detector. (There is no need to remove the combustible gas sensor.)

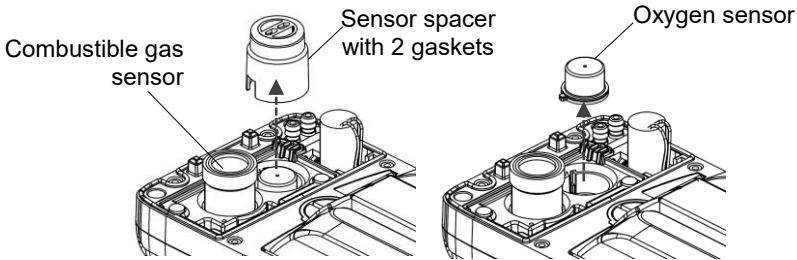
**CAUTION**

- Firmly tighten the four screws with recommended torque. Loose screws may cause water entry into the detector.
- Ensure that the pump motor harness is not entangled in the back cover while installing the cover. Failure to do so may impair the explosion-proof performance and gas detection.
- Normal gas detection is not possible if the gaskets are missing or installed incorrectly.

- (4) Install a new sensor in the same location where the old one was installed. Reinstall the sensor spacer.

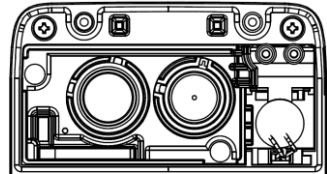

- (5) Install the back cover by tightening the four screws. (Recommended torque: 30 cN·m)

- (6) Attach the elastomer case and shoulder strap to the gas detector. Connect the gas sampling tube (or attachment) to the gas detector.

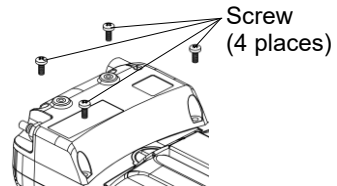

- (7) Turn on the gas detector. Check that the display changes from the warm-up screen to the gas concentrations screen. If “Sensor Error” is displayed, the sensor may not be installed correctly. Check the sensor for correct installation.

- (8) Block the tip of gas sampling tube (or attachment) and check that no pump motor sound is heard and that “Pump Error” is displayed. If “Pump Error” is not displayed, the sensor spacer’s gaskets may be missing or the screws may be loose. Open the back cover and recheck.

If “Pump Error” is not displayed even after blocking and checking repeatedly, the gaskets may be worn or the pump may be broken. Contact New Cosmos or your New Cosmos representative for repair.

6. Maintenance

This product is a precision instrument. Please perform the periodical checks and inspections below to maintain the detector's performance and ensure safety. In the event of a failure to follow the safety precautions (pages 6 to 8), such as impact shock from dropping or water ingress inside the detector, or use in conditions outside the specifications (pages 48-52), such as usage in temperature/humidity exceeding the specified range, please contact New Cosmos or your New Cosmos representative for inspection (fees may apply).

Routine Check

Check item	Description
LCD indication	Check that all segments (all letters and icons) are displayed on the LCD. ("Power on" on pages 14-15)
Alarm function	Check that the alarm light and audio alarm work properly. ("Alarm Test" on page 33 for the procedure)
Alarm test using actual gas	Prepare test gas that slightly exceeds the alarm set value. Let the detector sample the test gas and check for alarm operation. Check whether the reading changes and when it reaches the alarm set value, the alarm light blinks red and audio alarm starts. If the reading does not change properly, the alarm light does not blink, or the audio alarm does not sound even though mute is off, contact New Cosmos or your New Cosmos representative for inspection.
Gas sampling tube	Check that the tube is securely connected to the gas detector. Check that the tube is free of wear or damage that may interfere with operation. Replace it with a new one, if worn or damaged.
Drain filter or Cooling drain filter	Check that the filter element inside the drain filter is clean and dry. Replace the element with a new one if dirty or wet.
Filter element	Check that water is not present inside the drain filter. If present, remove it and make sure that the drain filter and filter case are completely dried and cleaned. ("Filter Element Replacement" on pages 40-41)
Battery level	<p>Check the battery level indicator at the top-right corner of the LCD. If the battery level is low, replace/charge the batteries. "Battery Replacement" and "Charge Batteries" on pages 38-40.</p> <div style="border: 1px dashed black; padding: 5px;"> <p>NOTE</p> <ul style="list-style-type: none"> • When used at low temperature, the battery life will be shorter than when used at room temperature due to the battery's characteristics. It is recommended to have spare batteries, or replace/charge the batteries earlier. • When using rechargeable batteries, it is recommended to charge them earlier when  is displayed. </div>
Airtightness	Turn on the detector. Cover the gas sampling tube's probe nozzle tip with finger. Check that the "Pump Error" is displayed on the LCD. If displayed, then the operation is normal. Press the ► button to resume the pump operation. If "Pump Error" is not displayed, airtightness is not good. The gaskets may be missing or damaged, gas sampling tube may be worn, or pump failure may occur. Replace them with new ones or contact us for repair.

Annual Inspection

Contact New Cosmos or your New Cosmos representative to perform a periodic inspection including sensor calibration and filter replacement at least once a year to maintain the product accuracy.



WARNING

- The recommended replacement cycle for combustible sensors is three years. Replace the sensor with a new one every three years to ensure correct detection.
- The recommended replacement cycle for oxygen sensors is two years. Replace the sensor with a new one every two years to ensure correct detection.
- The above-recommended cycles are only an estimate based on normal use and proper maintenance without exposure to high concentration gas or gas poisoning; therefore, no guarantee is provided.
- The replacement cycle changes depending on the use and environment conditions. Check your detector before use for normal operation, when it was used outside the specified conditions, such as high temperature/humidity, impact by falling from a high place, exposure to water splash, high concentration gas or gas poisoning.

Cleaning

If the detector is dirty, wipe it off with a soft dry cloth, or a cloth fully wrung out of water (dry enough not to leave the product surface wet). Do not use any alcohol or detergent.

Consumable Parts

Part Name	Model	Remarks
Filter element for drain filter	FE-2	Replace at least once a year or when dirty or wet.
Filter element for cooling drain filter	FE-10	Replace at least once a year or when dirty or wet.
Sensor spacer with two gaskets		Replace when the sensor spacer or its gasket is damaged or deformed.
Elastomer case		Replace when worn or damaged.
1m gas sampling tube	SH-301K-1A	With drain filter and probe nozzle included
Drain filter	DF-112	
Attachment	AT-2B	Short probe
Oxygen sensor	OS-5	For replacement
Nickel metal hydride AA battery (rechargeable)	HR-3UTG	Replace when the continuous operation time becomes extremely short or every two years at least.

*The warranty period for consumable parts is one year from the date of purchase. The warranty terms and conditions are the same as the one for the product (gas detector).

7. Troubleshooting

Before contacting us for service repair, perform basic troubleshooting using the table below. If the detector locks up (cannot be turned off), remove all batteries. After a few minutes, put the batteries back in and turn on the detector.

Symptom	Cause	Action	Reference
Pressing the power button does not turn on the power	Battery orientation incorrect	Remove batteries and reinsert them in the correct orientation.	"Battery Replacement" and "Charge Batteries" on pages 38-40
	Battery depleted	Replace/charge batteries.	
No audio sounds	Audio is set to MUTE	Unmute the audio	"Audio volume control" on page 31
Cannot detect gas	Gas sampling tube damaged	Replace the gas sampling tube with a new one.	
Error message appears	See "Error Messages" on pages 36-37.		
"0" or "0.0" blinks for gas concentration	The reading shifts in the negative area. It indicates there is a possibility that zero adjustment was performed in a gas atmosphere or the unit was exposed to high concentration gas	Perform zero adjustment in clean air.	"Zero adjustment" on page 22
Reading does not change while sampling gas or in gas atmosphere	Impact on the device, e.g., by falling from a high place	Wait for 10 seconds. If the reading remains unchanged after 10 seconds, turn the unit off and then turn it on in clean air.	

8. Warranty

The warranty period is one (1) year from the date of purchase.

You are entitled to the limited warranty, if the product malfunctions due to a manufacturing defect during normal use in accordance with the instruction manual, specifications and labels.

Warranty Scope

If the product fails or is found to be damaged due to a manufacturing defect during the warranty period, and used in accordance with the instruction manual and specifications, we will provide a free replacement and repair service. This warranty covers the New Cosmos product/parts only and not third party product/parts.

Warranty Exclusions

The following will be repaired at the cost of customer even during the warranty period.

- (1) Failures and damages incurred by incorrect use, deliberate acts or negligence of the user.
- (2) Failures and damages caused by disaster, earthquake, storm and flood, lightning, extreme climate, abnormal power supply voltage, excessive electromagnetic interferences, or other acts of God.
- (3) Failures and damages resulting from repair and/or modification by non-New Cosmos certified technicians.
- (4) Consumables and failures and damages resulting from improper consumable replacement.
- (5) Other failures and damages not attributable to the manufacturer.

9. Specifications

■ Product Specifications

Model	XP-3310II, XP-3318II, XP-3340II, XP-3360II-W, XP-3368II-W, XP-3360II, XP-3368II, XP-3380II, XP-3380II-E
Target gas	As per Table 9-1
Detection principle	As per Table 9-1
Sensor operation method	Continuous
Gas sampling method	Extractive
Measuring range (Service range ¹)	As per Table 9-1
Accuracy ² (Service range excluded)	As per Table 9-1
Resolution	As per Table 9-1
Gas alarm set value	As per Table 9-1
Response time ³	As per Table 9-1
Gas alarm method	Beeping with blinking red light and "AL" icon on the LCD
Device error notification	Beeping with blinking yellow light and error message on the LCD
Power source	<ul style="list-style-type: none"> • Non-rechargeable alkaline AA battery x4: Toshiba LR6, Panasonic LR6X, Duracell MN1500, Energizer E91 or Varta 4106 • Rechargeable nickel metal hydride AA battery x4: New Cosmos HR-3UTG
Continuous operation time ⁴	As per Table 9-1
Operating temperature/humidity	-20°C to +50°C 0 to 95%RH No condensation. No sudden change in temperature or humidity.
Operating pressure	Atmospheric pressure (800 to 1100 hPa)
Compliance	<p>Models which use non-rechargeable alkaline AA batteries:</p> <p>ATEX: Ex II 1G Ex ia da IIC T4 Ga (Other than XP-3380II) Ex II 1G Ex ia IIC T4 Ga (XP-3380II)</p> <p>IECEX: Ex ia da IIC T4 Ga (Other than XP-3380II) Ex ia IIC T4 Ga (XP-3380II)</p> <p>UL: Class I, Division 1, Groups A, B, C and D; Class I, Zone0 AEx da ia IIC Ga (Other than XP-3380II) Class I, Division 1, Groups A, B, C and D; Class I, Zone0 AEx ia IIC Ga (XP-3380II)</p> <p>The device has a temperature code of T4 when used with primary cells or T3 when used with secondary cells.</p> <p>Models which use rechargeable nickel metal hydride AA batteries:</p> <p>ATEX: Ex II 1G Ex ia da IIC T3 Ga (Other than XP-3380II) Ex II 1G Ex ia IIC T3 Ga (XP-3380II)</p> <p>IECEX: Ex ia da IIC T3 Ga (Other than XP-3380II) Ex ia IIC T3 Ga (XP-3380II)</p> <p>UL: Class I, Division 1, Groups A, B, C and D; Class I, Zone0 AEx da ia IIC Ga (Other than XP-3380II) Class I, Division 1, Groups A, B, C and D; Class I, Zone0 AEx ia IIC Ga (XP-3380II)</p> <p>The device has a temperature code of T4 when used with primary cells or T3 when used with secondary cells.</p> <p>CE (ATEX, EMC, RoHS, RE and LVD, directives)</p>

(Continued on next page)

Compliance	Sensor symbol for CS, CT and CH sensors ATEX:  II 1G Ex da IIC Ga IECEX: Ex da IIC Ga
Ingress protection	Equivalent to IP67 ^{*5}
Wireless	Bluetooth 5.0 ^{*6}
Main features	Self-diagnosis (sensor error), zero adjustment, battery level indication, flashlight, peak hold, LCD backlight, audio gas alarm muting during gas alarm, time indication, alarm test, alarm volume change, audio muting, data logging ^{*7}
Dimensions	W91×H164×D44 mm
Mass	Approx. 460 g (including batteries)

* Above specifications may be subject to change without notice.

*1. Reference indication beyond the measuring range.

*2. Under an identical measurement condition.

*3. Time for 90% response (at 20 ± 2°C ambient temperature. Test gas: Methane).

*4. Powered by non-rechargeable alkaline AA batteries (Toshiba LR6) or rechargeable nickel metal hydride AA batteries (New Cosmos HR-3UTG), at 25°C, with no alarm, backlight off, data logging off, and Bluetooth off. The time varies according to the circumstances, condition of use, storage period, battery manufacturer, etc.

*5. Dustproof and waterproof structure, which meets the New Cosmos test complying with IEC60529 ingress protection code IP67 in the condition of the brand-new detector. However, this ingress protection code IP67 does not guarantee any gas detection.

IP67 refers to a combined structural rating (IP6X) in which a unit is tested by a dust test where the unit's inside is depressurized by a maximum of 2kPa from ambient air pressure and it is placed in a chamber containing a quantity of dust to verify that there is no accumulation of dust inside the unit, and a structural rating (IPX7) in which a unit is slowly immersed in a stationary water bath filled with normal tap water with the bottom of the unit at 1m from the water surface for 30 minutes to verify that there is no water entry and damage from exposure. (The inlet and outlet of the detector do not comply with IP67 requirements.)

*6. Use only in the EU and Japan.

*7. Data logging is available only with the unit with Bluetooth function installed when shipped.

Note: This equipment has been tested and found to comply with the limits for a Class B digital device, pursuant to Part 15 of the FCC Rules. These limits are designed to provide reasonable protection against harmful interference in a residential installation. This equipment generates, uses and can radiate radio frequency energy and, if not installed and used in accordance with the instructions, may cause harmful interference to radio communications. However, there is no guarantee that interference will not occur in a particular installation. If this equipment does cause harmful interference to radio or television reception, which can be determined by turning the equipment off and on, the user is encouraged to try to correct the interference by one or more of the following measures:

- Reorient or relocate the receiving antenna.
- Increase the separation between the equipment and receiver.
- Connect the equipment into an outlet on a circuit different from that to which the receiver is connected.
- Consult the dealer or an experienced radio/TV technician for help.

This device complies with part 15 of the FCC Rules. Operation is subject to the following two conditions: (1) This device may not cause harmful interference, and (2) this device must accept any interference received, including interference that may cause undesired operation.

This equipment complies with FCC radiation exposure limits set forth for an uncontrolled environment and meets the FCC radio frequency (RF) Exposure Guidelines as this equipment has very low levels of RF energy.

Table 9-1

Model	XP-3310II	XP-3318II	
Target gas	Combustible gas/ solvent gas	Combustible gas/ solvent gas	Oxygen
Detection principle	Catalytic	Catalytic	Galvanic cell
Measuring range (Service range)	0–100%LEL (100.1–110.0%LEL)	0–100%LEL (100.1–110.0%LEL)	0–25vol% (25.1–50.0vol%)
Accuracy	±5%F.S.	±5%F.S.	±0.3vol%
Resolution	0.1%LEL	0.1%LEL	0.1vol%
Gas alarm set value	20%LEL	20%LEL	18vol%
Response time	T90: 30 seconds	T90: 30 seconds	–
Continuous operation time	Approx.15 hours	Approx.15 hours	

F.S.: Full scale

Model	XP-3360II-W	XP-3368II-W	
Target gas	Combustible gas/ solvent gas	Combustible gas/ solvent gas	Oxygen
Detection principle	Catalytic	Catalytic	Galvanic cell
Measuring range (Service range)	0.0–100.0%LEL (100.1–110.0%LEL) Switchable to display in ppm	0.0–100.0%LEL (100.1–110.0%LEL) Switchable to display in ppm	0–25vol% (25.1– 50.0vol%)
Accuracy	≤ 1000ppm: 100ppm 1001ppm<n≤10000ppm: ±500ppm Other than above: ±5%F.S.	≤ 1000ppm: ±100ppm 1001ppm<n≤10000ppm: ±500ppm Other than above: ±5%F.S.	±0.3vol%
Resolution	0.1%LEL or 1 ppm	0.1%LEL or 1 ppm	0.1vol%
Gas alarm set value	20%LEL	20%LEL	18vol%
Response time	T90: 30 seconds	T90: 30 seconds	–
Continuous operation time	Approx.15 hours	Approx.15 hours	

F.S.: Full scale

Table 9-1 (continued)

Model	XP-3360II	XP-3368II	
Target gas	Combustible gas/ solvent gas	Combustible gas/ solvent gas	Oxygen
Detection principle	Catalytic	Catalytic	Galvanic cell
Measuring range (Service range)	0–5000 ppm (5001–5500 ppm)	0–5000 ppm (5001–5500 ppm)	0–25vol% (25.1–50.0vol%)
	0–10000 ppm (10001–11000 ppm)	0–10000 ppm (10001–11000 ppm)	
Accuracy	≤10%F.S.: ±1%F.S. >10%F.S.: ±5%F.S.	≤10%F.S.: ±1%F.S. >10%F.S.: ±5%F.S.	±0.3vol%
Resolution	1 ppm	1 ppm	0.1vol%
Gas alarm set value	250 ppm or 500 ppm	250 ppm or 500 ppm	18vol%
Response time	T90: 30 seconds	T90: 30 seconds	–
Continuous operation time	Approx. 15 hours	Approx. 15 hours	

F.S.: Full scale

Model	XP-3340II	XP-3380II	XP-3380II-E
Target gas	Combustible gas/ solvent gas	Oxygen	Oxygen in combustion exhaust
Detection principle	Thermal conductivity	Galvanic cell	
Measuring range (Service range)	0–100vol% (100.1–110.0vol%)	0–25vol% (25.1–50.0vol%)	
Accuracy	±5%F.S.	±0.3vol%	
Resolution	0.1vol%	0.1vol%	
Gas alarm set value	50vol%	18vol%	
Response time	T90: 60 seconds	–	
Continuous operation time	Approx. 100 hours	Approx. 100 hours	

F.S.: Full scale

■ Explosion-proof Specifications

Model		XP-33xxII
Type of protection		<p>Models which use non-rechargeable alkaline AA batteries:</p> <p>ATEX:  II 1G Ex ia da IIC T4 Ga (Other than XP-3380II)  II 1G Ex ia IIC T4 Ga (XP-3380II)</p> <p>IECEX: Ex ia da IIC T4 Ga (Other than XP-3380II) Ex ia IIC T4 Ga (XP-3380II)</p> <p>UL: Class I, Division 1, Groups A, B, C and D; Class I, Zone0 AEx da ia IIC Ga (Other than XP-3380II) Class I, Division 1, Groups A, B, C and D; Class I, Zone0 AEx ia IIC Ga (XP-3380II)</p> <p>The device has a temperature code of T4 when used with primary cells or T3 when used with secondary cells.</p> <p>Models which use rechargeable nickel metal hydride AA batteries:</p> <p>ATEX:  II 1G Ex ia da IIC T3 Ga (Other than XP-3380II)  II 1G Ex ia IIC T3 Ga (XP-3380II)</p> <p>IECEX: Ex ia da IIC T3 Ga (Other than XP-3380II) Ex ia IIC T3 Ga (XP-3380II)</p> <p>UL: Class I, Division 1, Groups A, B, C and D; Class I, Zone0 AEx da ia IIC Ga (Other than XP-3380II) Class I, Division 1, Groups A, B, C and D; Class I, Zone0 AEx ia IIC Ga (XP-3380II)</p> <p>The device has a temperature code of T4 when used with primary cells or T3 when used with secondary cells.</p>
		<p>Type of protection for CS, CT, and CH sensors</p> <p>ATEX:  II 1G Ex da IIC Ga</p> <p>IECEX: Ex da IIC Ga</p> <p>(Max. input power: 1.3 W)</p>
		Ingress protection
Rating	Power source	<p>3.0 VDC</p> <p>Toshiba LR6 x 4pcs</p> <p>Panasonic LR6X x 4pcs</p> <p>Duracell MN1500 x 4pcs</p> <p>Energizer E91 x 4pcs, or</p> <p>Varta 4106 x 4pcs</p> <p>2.6 VDC</p> <p>New Cosmos HR-3UTG x 4pcs</p>
	Ambient temperature	-20°C to +50°C

External Markings for Explosion-proof Models

1. Manufacturing label

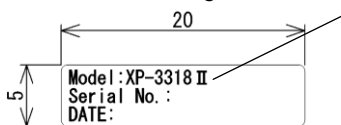

Models:
 XP-3310II
 XP-3318II
 XP-3340II
 XP-3360II
 XP-3360II-W
 XP-3368II
 XP-3368II-W
 XP-3380II
 XP-3380II-E

2. Explosion-proof label (ATEX, IECEx)

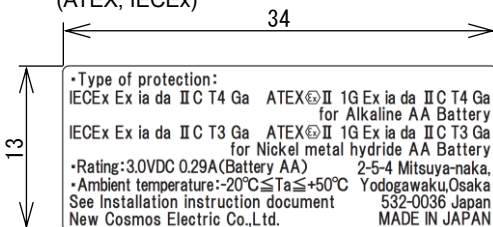

(UL)

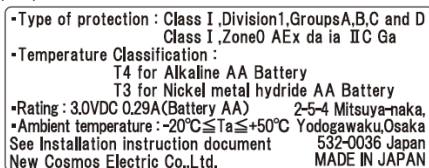

3. UL marking label

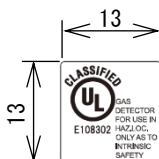

4. CE marking label

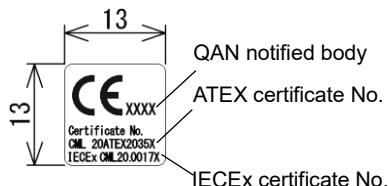

5. Warning label for battery handling

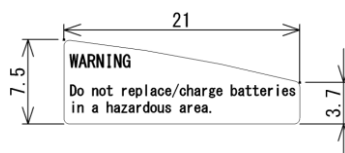

6. Warning label for battery type check

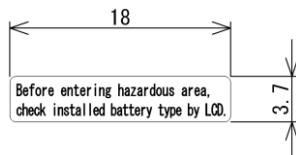

(Size is in mm)

- Applicable standards: (ATEX) EN 60079-0: 2018
 EN 60079-1: 2014
 EN 60079-11: 2012
 (IECEx) IEC 60079-0: 2017 Edition 7.0
 IEC 60079-1: 2014 Edition 7.0
 IEC 60079-11: 2011 Edition 6.0
 (UL) UL 60079-0 : 7th Edition
 UL 60079-1 : 7th Edition
 UL 60079-11 : 6th Edition
 UL 913 :8th Edition

10. Disposal

Dispose of a used gas detector, sensor or battery as industrial waste in accordance with the applicable local laws and regulations.

Battery disposal

Used batteries must be disposed of in accordance with the applicable laws and regulations.

The Waste Electrical and Electronic Equipment (WEEE) directive (2012/19/EU) is intended to promote recycling of electrical and electronic equipment and their components at end of life. This symbol (crossed-out wheeled bin) indicates separate collection of waste electrical and electronic equipment in the EU countries. This product uses batteries. Batteries must be recycled or disposed of properly. At the end of its life, batteries must undergo separate collection and recycling from general or household waste. Please use the return and collection system available in your country for the disposal of the batteries.



11. Detection Principle

● Catalytic sensor (combustible gas)

Catalytic combustion occurs on the catalytic layer applied on a platinum coil even if the gas concentration is well below the lower flammable limit (LFL). This causes a rise in temperature of the platinum coil and increases its electrical resistance. This change is read as a differential voltage using a bridge circuit. This process enables detection of combustible gases in air up to the lower explosive limit (LFL).

● Thermal conductivity sensor

A thermal conductivity sensor is based on the principle that some gases have a different thermal conductivity from air.

When a gas comes in contact with a heated platinum coil coated with an inert substance (sensor element), the gas will conduct the heat from the coil more or less efficiently than air. This results in a change of the temperature of the sensor element, causing a change in the resistance of the platinum coil. The resistance change is read as differential voltage using a bridge circuit. The differential voltage is near proportional to the gas concentration.

This type of sensor is limited to detection of gases whose thermal conductivity is different from air but it can detect gases in the range from 0 to 100 vol%.

● Galvanic cell sensor (oxygen)

The sensor consists of two electrodes, a membrane and an electrolyte.

The electrodes are two different metals, noble metal (Pt, Ag) and base metal (Pb). The noble metal electrode has contact with air via a Teflon membrane. Connecting load resistance to both electrodes generates a potential difference, which promotes the following reactions:



As a result, the current proportional to the oxygen concentration in the air flows from the noble metal electrode to the base metal electrode via the external circuit. Since the electromotive force changes depending on the temperature, a thermistor is added to compensate for the ambient temperature variations.

This oxygen sensor is effected by atmospheric pressure because of its principle. When the unit is turned on in clean air at a standard atmospheric pressure (1,013hPa), the reading will be automatically adjusted to 20.9vol%. The reading will change in accordance with the atmospheric pressure change, even though the oxygen level does not change.

For example, if the unit is relocated to an elevation of 1,000m above sea level (900hPa), clean air, the reading will change from 20.9vol% to 18.6vol%. If the unit is turned on, auto zeroing will start and the reading will be adjusted to 20.9vol%.

To convert this figure to the one at standard atmospheric pressure (1,013hPa), multiply it by the correction factor (900÷1013=0.89) to obtain the corrected oxygen level, 18.6vol% (20.9 x 0.89).

Atmos. pressure	800	850	900	950	960	970	980	990	1000	1010	1013	1020	1030	1040	1050	1100
Correction coefficient	0.79	0.84	0.89	0.94	0.95	0.96	0.97	0.98	0.99	1.00	1.00	1.01	1.02	1.03	1.04	1.09
O ₂ level (vol%)	16.5	17.6	18.6	19.6	19.9	20.1	20.3	20.5	20.7	20.9	20.9	21.1	21.3	21.5	21.7	22.7

12. Glossary

Term	Definition
Target gas	Specific gas to be detected and used to trigger alarms.
Detection range or measuring range	A range of target gas concentrations that can be displayed and trigger alarms.
Service range	A range of target gas concentrations the detector is able to indicate, which are usually outside the Detection Range and used only as reference.
Zero adjustment (zeroing)	To adjusting the zero point (or 20.9% for oxygen) in clean air. Clean air: air free from target or interfering gases, and composed of 20.9-21.0vol% oxygen in dry conditions. Gas atmosphere: Air containing target or interfering gases.
Span adjustment	To adjust the indicated values by using span gas.
Explosion-proof structure	Structure of an electrical apparatus to not become an ignition source in a flammable atmosphere
Intrinsically safe (IS) structure	Structure tested (e.g., spark test) to not become an ignition source in a flammable atmosphere due to an electrical spark or hot surface during normal operation and fault conditions.
Hazardous area	An area in which an explosive atmosphere is present, or may be expected to be present, in quantities such as to require special precautions for the construction, installation and use of electrical apparatus.
Non-hazardous area	An area in which an explosive atmosphere is not expected to be present in quantities such as to require special precautions for the construction, installation and use of electrical apparatus.
%LEL	Concentrations of combustible gas given in terms of percent of the lower explosion limit.
vol%	Gas concentrations given in terms of percent of cubic volume.
ppm	Gas concentrations given in terms of millionth part of cubic volume.
LEL	Lower Explosive Limit. Lowest concentration (percentage) of a gas or vapor in air capable of producing a flash fire, or explosion in the presence of an ignition source like arc, flame or heat.

Appendix: Utility for Gas Detector App

A1. Utility for Gas Detector

The Utility for Gas Detector app is a utility application that connects your iOS or Android device (e.g., Android phone, iPhone, iPad) to a gas detector via Bluetooth. This allows your iOS or Android device to display the real-time gas concentrations, temperature and humidity levels detected by the gas detector and send you an email alert in case of a gas alarm or detector error (e.g., pump error, sensor error, and empty battery). One iOS or Android device can be paired with one gas detector at a time.

Please read this appendix to ensure correct use of this app.

A2. Compatible iOS/Android Devices

- iOS 10.0 or higher
- Android 7.0 or higher

NOTE

For easy understanding, the term “smartphone” is used to indicate your iOS or Android device (e.g., Android phone, iPhone, iPad) throughout this Appendix.

A3. Language Settings

English and Japanese language settings are available for this app.

NOTE

- When Japanese is selected for your smartphone’s OS, the Japanese language is automatically set for this app. When the language other than Japanese is selected, English language is automatically set.
- For the language selection procedure, refer to the your smartphone’s instruction manual.

A4. App Installation and Uninstallation

A4-1. Installation

- iOS
 - (1) Open **App Store**.
 - (2) Tap **Search** on the bottom-right corner.
 - (3) Tap the search box.
 - (4) Enter “utility for gas detector” in the box, then tap **Search** to start the search.
 - (5) “Utility for gas detector” will be displayed.
 - (6) Tap **GET** to start installation.
 - (7) Once the installation is complete, a Utility for Gas Detector icon will be created on the home screen.

■ Android

- (1) Open **Google Play**.
- (2) Tap **Apps** in the bottom navigation bar.
- (3) Tap the search box.
- (4) Enter “utility for gas detector” in the box, then tap **Search** to start the search.
- (5) “Utility for gas detector” will be displayed.
- (6) Tap **INSTALL** to start installation.
- (7) Once the installation is complete, a Utility for Gas Detector icon will be created on the home screen.

A4-2. Uninstallation

■ iOS

- (1) Tap and hold the Utility for Gas Detector icon to display a menu.
If “x” appears on the top-left corner of every icon and all the icons start wiggling, then tap “x” on the app you want to delete, and proceed to Step (3).
- (2) Tap **Remove App** from the menu.
- (3) A message asking if you want to delete this app will appear.
- (4) Tap **Delete App**.

■ Android



- (1) Open the Settings icon from the home screen or the Apps drawer.
- (2) Tap **Apps & notifications**.
- (3) Tap **App info** to display all the installed apps.
- (4) Select “Utility for gas detector.”
- (5) Tap **Uninstall**.
- (6) A message asking if you want to uninstall this app will appear.
- (7) Tap **OK** to confirm.

NOTE

For full information on the app installation/uninstallation procedure, refer to your smartphone’s instruction manual.

A5. Pairing with a Gas Detector

Run the Utility for Gas Detector app and connect it to a gas detector by following the steps below.

- (1) Turn on the gas detector, then turn its Bluetooth on. (3-4. “Settings” on page 27)
- (2) Turn on your smartphone’s Bluetooth. 
- (3) Tap the Utility for Gas Detector icon  on your smartphone.
- (4) If a popup message appears requesting to allow the app to access your location, allow the access.
- (5) The **Select device** screen will appear. Select the gas detector that you want to connect to. (Page iv)
- (6) Enter the last 5 digits of the serial number of the gas detector. (Page v)
- (7) “Connecting...” will be displayed.
- (8) When the pairing is complete, the Gas concentration screen will appear. (Page vi)

NOTE

- Unless the pairing is disconnected (e.g., by turning off the detector, or tapping the Disconnect button on the screen), running this app will automatically initiate pairing with the last-connected gas detector without going through steps (5) and (6).
- Ensure that your desired gas detector is paired with.
- Unless the app is allowed to access your location, your smartphone may not pair with the gas detector depending on the smartphone type and this app cannot attach your location to emails.

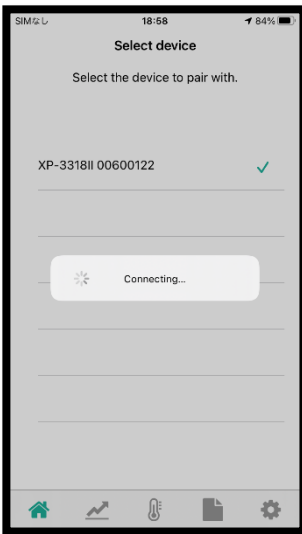

Select device screen

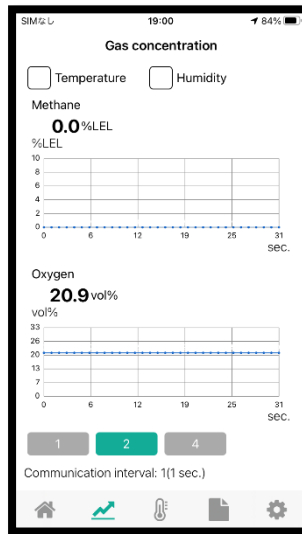

Gas concentration screen

A6. Select Device Screen

The buttons and indications on the **Select device** screen are described below. This screen enables you to select a gas detector to pair with via Bluetooth.

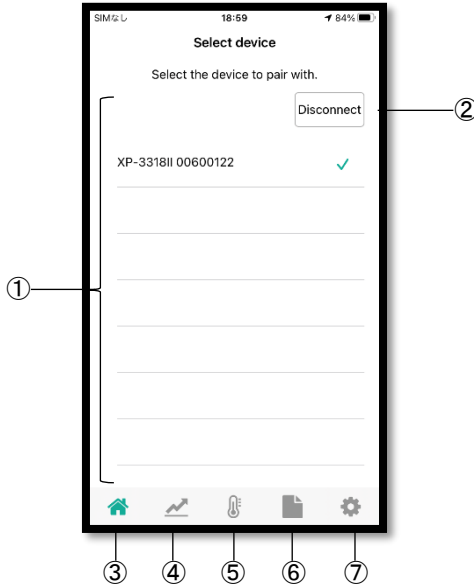

Item	Button/indication	Function
1	List of gas detectors ready for pairing	View the list of gas detector candidates that can be paired with your smartphone. Tap on the gas detector you want to pair with. A green checkmark appears to indicate the selection. If several gas detectors are present in the vicinity and the gas detector you want to pair with is consequently not shown on screen, swipe the screen and scroll up/down to find it. Tap on it to select it. If a popup message appears, requesting you to enter the last 5 digits of the detector's serial number, enter it. (Page v)
2	Disconnect button	Tap to terminate the pairing with the gas detector.
3	Home button	Tap to go to the Select device screen.
4	Gas concentration button	Tap to go to the Gas concentration screen.
5	Temperature and humidity button	Tap to go to the Temperature and Humidity screen.
6	Log data button	Tap to go to the Log data display screen.
7	Settings button	Tap to go to the Settings screen.

■ Serial Number Entry

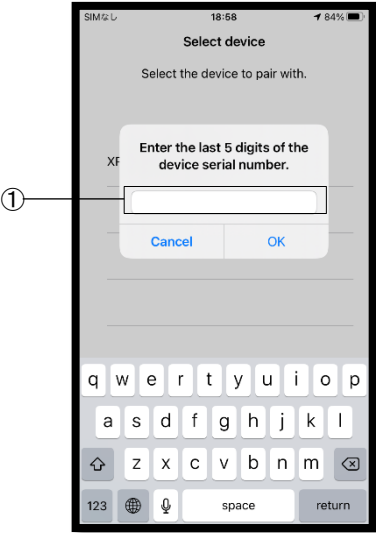

Item	Button/indication	Function
1	Serial number entry box	Enter the last 5 digits of the serial number of the gas detector. Tap OK to confirm. For example, when the serial number is “XP-3318II 00600122”, enter “00122.”

A7. Gas Concentration Screen

The buttons and indications on the **Gas concentration** screen are described below. This screen displays the real-time gas concentrations sent by the gas detector. Using this screen, you can change the gas types to be displayed and show/hide the temperature and humidity.

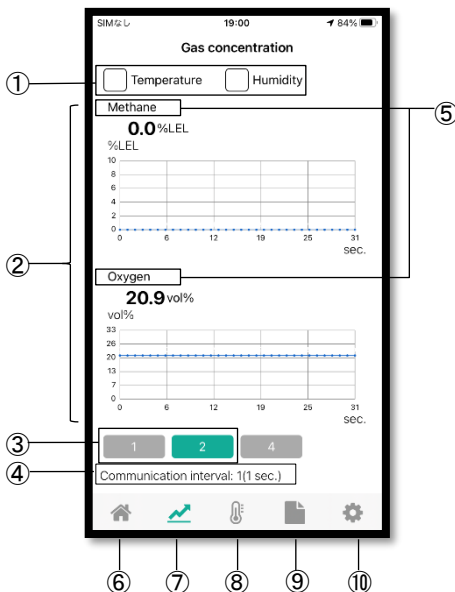

Item	Button/indication	Function
1	Temperature/Humidity checkbox	Tap to check/uncheck the box to show/hide the temperature and humidity in a graph form.
2	Gas data	View the <u>real-time gas concentration value and a trend graph of gas concentrations logged at the specified communication interval for each gas type. It is possible to pinch in/out (zoom in/out) on the graph. In the event of a gas alarm, the corresponding gas concentration value is red-highlighted.</u>
3	Buttons 1 and 2	Switch the number of gases to be displayed. 1: One gas (one graph) 2: Two gases (two graphs)
4	Communication interval	Displays the data logging interval between the gas detector and your smartphone via Bluetooth.
5	Gas type (change)	Tap to change the gas type to be displayed.
6	Home button	Tap to go to the Select device screen.
7	Gas concentration button	Tap to go to the Gas concentration screen.
8	Temperature and humidity button	Tap to go to the Temperature and Humidity screen.
9	Log data button	Tap to go to the Display log data screen.
10	Settings button	Tap to go to the Settings screen.

A8. Temperature and Humidity Screen

The buttons and indications on the **Temperature and Humidity** screen are described below. This screen shows the real-time temperature and humidity sent from the gas detector.

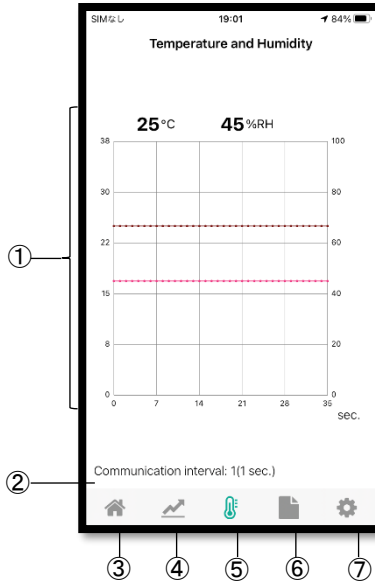

Item	Button/indication	Function
1	Temperature and humidity data	Displays the real-time temperature and humidity levels and their trend graphs. It is possible to pinch in/out (zoom in/out) on the graph.
2	Communication interval	Displays the data logging interval between the gas detector and your smartphone via Bluetooth.
3	Home button	Tap to go to the Select device screen.
4	Gas concentration button	Tap to go to the Gas concentration screen.
5	Temperature and humidity button	Tap to go to the Temperature and Humidity screen.
6	Log data button	Tap to go to the Display log data screen.
7	Settings button	Tap to go to the Settings screen.

A9. Display Log Data Screen

The buttons and indications on the **Display log data** screen are described below. Using this screen, you can view the old log data recorded in the gas detector.

■ List of Log Data

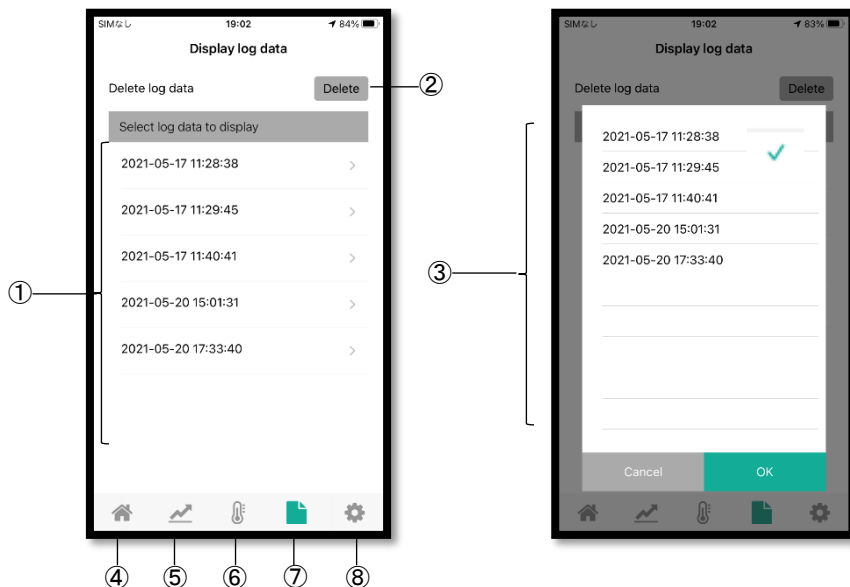

Item	Button/indication	Function
1	List of log data	Lists log data logged and saved by the gas detector. If your desired log data is not shown on the screen, swipe the screen and scroll up/down to find it. Taping it will show the content of the data in a graph form (Page ix)
2	Delete button	Tap the Delete button to display a list of log data to be deleted. Tap to select the one you want to delete from the list. A green checkmark appears to indicate the selection
3	List of log data to be deleted	Tap OK to delete it.
4	Home button	Tap to go to the Select device screen.
5	Gas concentration button	Tap to go to the Gas concentration screen.
6	Temperature and humidity button	Tap to go to the Temperature and Humidity screen.
7	Log data button	Tap to go to the Display log data screen.
8	Settings button	Tap to go to the Settings screen.

■ Viewing the Contents of the Log Data

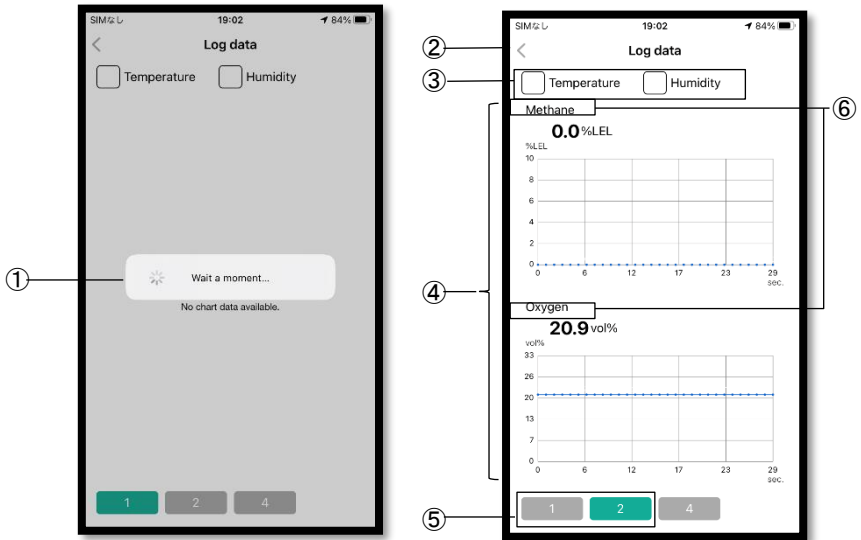

Item	Button/indication	Function
1	"Wait a moment..." message	Appears while the app is accessing and acquiring the log data from the gas detector; if the data size is bigger, it will take longer.
2	Back button	Tap to return to the Display log data screen. (Tap the < button instead on Android phones)
3	Temperature/Humidity	Tap to check/uncheck the box to show/hide the temperature and humidity.
4	Gas data	View the gas concentration data saved in the gas detector, in a graph form for each gas type. It is possible to pinch in/out (zoom in/out) on the graph.
5	Buttons 1 and 2	Switch the number of gases to be displayed. 1: One gas (one graph) 2: Two gases (two graphs)
6	Gas type (change)	Tap to change the gas type to be displayed.

A10. Settings Screen

The buttons and indications on the **Settings** screen are described below. This screen is used to operate various settings such as those for a connected gas detector, email, and user information.

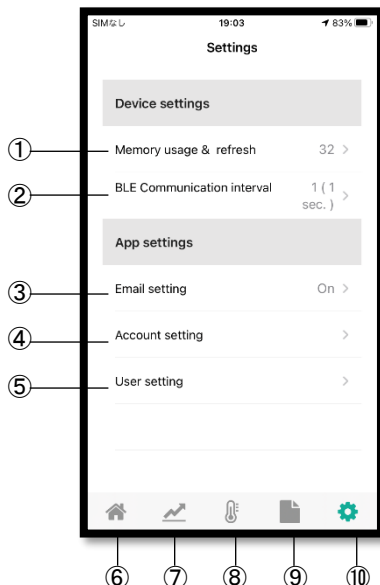

Item	Button/indication	Function
1	Memory usage & refresh	Displays the memory usage of the gas detector. The number shown on the right is the current memory usage percentage. E.g., “32” indicates “32% used.” Tap to go to the Memory usage & refresh screen, where you can view the memory usage and remaining logging time and delete all data logs from the detector. (Page xi)
2	BLE communication interval	Displays the communication interval with a gas detector via Bluetooth. The number shown on the right is the currently set interval. E.g., “1” (1 sec.) represents “1 second.” Tap to go to the BLE Communication interval screen, where you can change the interval. (Pages xii and xiii)
3	Email setting	Displays on/off status of the “send email” function. Tap to go to the Email setting screen, where you can change email settings. (Page xv)
4	Account setting	Tap to go to the Account setting screen, where you can set the ID and password. (Page xvi)
5	User setting	Tap to go to the User setting screen, where you can set the name, telephone number, etc. (Page xvii)

Item	Button/indication	Function
6	Home button	Tap to go to the Select device screen.
7	Gas concentration button	Tap to go to the Gas concentration screen.
8	Temperature and humidity button	Tap to go to the Temperature and Humidity screen.
9	Log data button	Tap to go to the Display log data screen.
10	Settings button	Tap to go to the Settings screen.

A10-1. Memory Usage & Refresh Screen

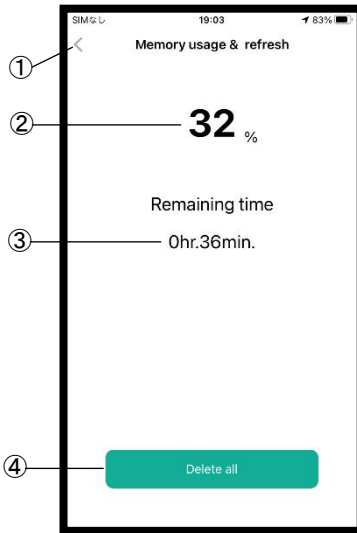

Item	Button/indication	Function
1	Back button	Tap to return to the Settings screen. (Tap the < button instead on Android phones)
2	Memory usage	Displays the current memory usage.
3	Remaining time	Displays the time remaining before the logging stops (in the gas detector), estimated based on the communication interval that is currently set.
4	Delete all button	Deletes all data logs from the gas detector.

A10-2. BLE Communication Interval Screen

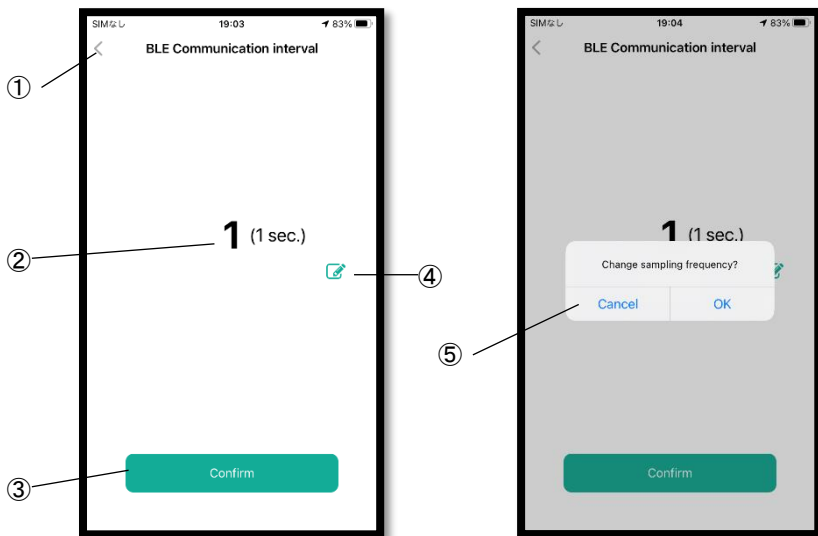

Item	Button/indication	Function
1	Back button	Tap to return to the Settings screen. (Tap the < button instead on Android phones)
2	BLE communication interval	Text in brackets indicates an applicable time unit. E.g.,: 2 (1 sec.) represents “2 seconds.” 5 (100 ms.) represents “500 milliseconds.”
3	Confirm button	Tap to update the interval to the currently displayed value.
4	Edit button	Tap to open the edit page and edit the BLE communication interval value. (Page xiii)
5	Confirmation message	Appears when the Confirm button is tapped. Tap OK to confirm the setting.

A10-3. BLE Communication Interval Edit Page

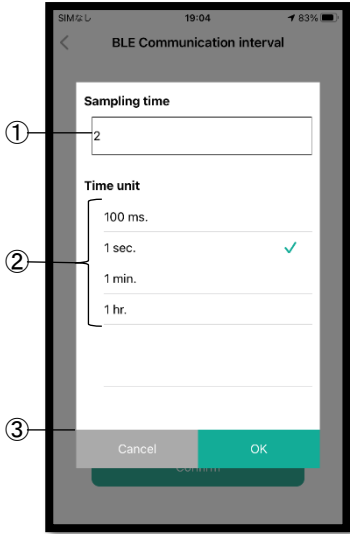

Item	Button/indication	Function
1	Sampling time	Enter the integer part of your desired BLE communication interval value here.
2	Time unit	Select your desired time unit from the list.
3	OK/Cancel button	Tap OK to confirm the editing, or tap Cancel to delete the editing. The screen then returns to the BLE Communication interval screen.

A10-4. Turning on the Send Email Function

This app sends you an email alert about a gas an event detected by the gas detector (e.g., a gas alarm, a device error, alarm clearance, error clearance). In order to activate this function, follow the steps below.

- (1) Open the app. Pair it with a gas detector. When the pairing is complete, the **Gas concentration** screen will appear.
- (2) Tap the settings button the bottom bar to go to the **Settings** screen.
- (3) Perform the account setting. (Page xvi)
Before starting the account setting, you need to create a Gmail account and turn on **Less secure app access**. (Page xvi)
- (4) Perform the email setting. (Page xv)
- (5) Perform an email test to check if all the above settings are correct. If the settings are correct, a test mail will be delivered to the set email addresses. (Refer to “Test mail button” on page xv)

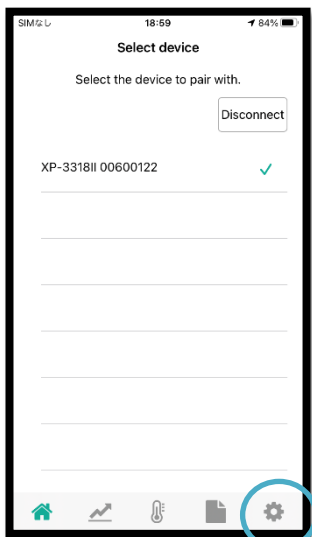

Settings button

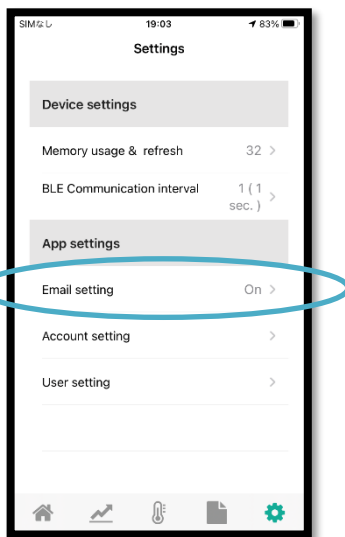

Email setting

A10-5. Email Setting Screen

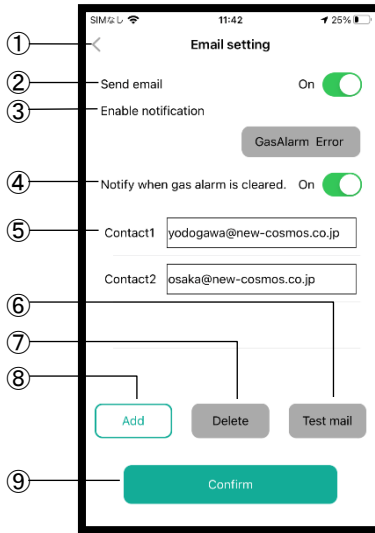

Item	Button/indication	Function
1	Back button	Tap to return to the Settings screen.
2	Send email	Selects whether or not to send email. On: Send Off: Do not send
3	Enable notification	Selects the conditions for triggering an email. Tap to select "GasAlarm" and "Error" respectively. GasAlarm: Send an email In case of a gas alarm Error: Send an email in case of a device error
4	Notify when gas alarm is cleared	Specifies whether or not a gas alarm clearance notification email is sent when a gas alarm is cleared. On: Send Off: Do not send
5	Contact	Enter the email addresses of contacts (people to be notified).
6	Test mail button	Sends a test mail to the registered contacts.
7	Delete button	Deletes the contacts. Tap to open the list of registered contacts. Tap to select the contact you want to delete. Tap OK to confirm.
8	Add button	Used to add a new contact. Tap and enter the address of a new contact.
9	Confirm button	Tap to confirm the changes you made to the email setting.

NOTE

Before using the **Test mail** button, ensure the following settings:

- Perform the account setting (see below for the procedure)
- After creating or adding the email address for a new contact, do not forget to tap on the **Confirm** button to finalize the setting.

A10-6. Account Setting Screen

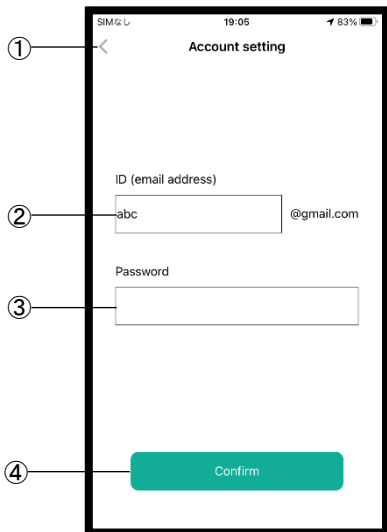

Item	Button/indication	Function
1	Back button	Tap to return to the Settings screen.
2	ID (email address)	Enter your Gmail address, which will be displayed as the sender of email notifications.
3	Password	Enter the password for your Gmail account.
4	Confirm button	Tap to confirm the changes you made to the account.

■ How to create a Gmail account

- (1) Go to the Google Account creation page below.
<https://support.google.com/mail/answer/56256?hl=eng>
- (2) Follow the steps on the screen to set up your account.
- (3) Use the account you created to sign in to Gmail.

■ How to turn on **Less secure app access** in the Gmail account

- (1) Go to the **Less secure app access** section of your Google Account.
You might need to sign in.
- (2) Turn **Allow less secure apps** on.

A10-7. User Setting

Set the user information to be stated in an email notification.

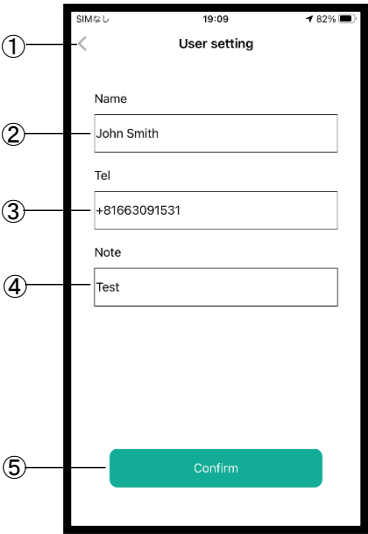

Item	Button/indication	Function
1	Back button	Tap to return to the Settings screen.
2	Name	Enter the name of the smartphone user.
3	Tel	Enter the telephone number of the smartphone user.
4	Note	Use this free space to take a note.
5	Confirm button	Tap to confirm the changes you made to the user details.

A11. Email Notification Sample

A typical email notification is shown below, assuming that a gas alarm for Oxygen was detected by the gas detector.

① Alarm activated for Oxygen

② User information
Name: Cosmos Taro
Tel:01234567890

③ Location:<https://www.google.com/maps?q=34.72639557908729,135.4670724180857>
Note:Test

④ Gas1,Gas2
Gas concentration:0%LEL,20.9vol%

Alarm set value:20.0%LEL,18.0vol%
Temperature:27°C
Humidity:45%RH
Serial No.:00600122
Time:2021/06/01 18:15:15

Item	Button/indication	Function
1	Notification	Notifies that a gas alarm, device error, gas alarm clearance, or device error clearance was detected.
2	User information	Displays the user details registered in the User setting screen.
3	Location information	Indicates the location where a gas alarm or device error occurred in the Google Maps address format. Enables you to access the address to check the location of the gas detector on the Google map.
4	Supplemental information	Indicates the gas concentration value, alarm set value, temperature, humidity, gas detector's serial number, time when a gas alarm/device error was detected.

This page intentionally left blank

Additional copies of this instruction manual may be purchased.
Contact New Cosmos or its authorized representative for ordering.
The contents of this manual are subject to change without notice.

Authorized representative:

Manufacturer:

NEW COSMOS ELECTRIC CO., LTD.
2-5-4 Mitsuya-naka, Yodogawa-ku,
Osaka 532-0036, Japan
www.newcosmos-global.com

NEW COSMOS ELECTRIC CO., LTD.